

BYLAW 2735/LUO/26

BEING A BYLAW OF THE TOWN OF STONY PLAIN IN THE PROVINCE OF ALBERTA TO PROHIBIT OR REGULATE AND CONTROL THE USE AND DEVELOPMENT OF LAND AND BUILDINGS IN THE TOWN OF STONY PLAIN

WHEREAS, Division 5 of the *Municipal Government Act*, RSA 2000, c. M-26, and amendments thereto, requires Council to pass a Land Use Bylaw;

NOW THEREFORE, the Council of the Town of Stony Plain in the Province of Alberta, duly assembled, hereby enacts as follows:

1.0.0 Title

1.1.0 This bylaw may be cited as the "Land Use Bylaw".

2.0.0 General

2.1.0 Schedule A: Land Use Bylaw is attached to and forming part of this bylaw.

2.2.0 Schedule B: Land Use Districts Map is attached to and forming part of this bylaw.

3.0.0 Effectiveness and Review

3.1.0 If any portion of this bylaw is declared invalid by a court of competent jurisdiction, then the invalid portion must be severed, and the remainder of the bylaw is deemed valid.

3.2.0 Bylaw 2719/LUO/25, 2721/LUO/25, 2726/LUO/25, 2728/LUO/25, and 2731/LUO/25 are hereby repealed.

3.3.0 This bylaw shall be reviewed within its fifth year, being 2031, or as deemed necessary.

3.4.0 This bylaw shall take full force and effect on the date it is passed.

Read a first time this 13th day of April, AD 2026.

Public hearing held this 11th day of May, AD 2026.

Read a second time this 11th day of May, AD 2026.

Read a third time this 11th day of May, AD 2026.



Mayor William Choy



Ann Laing
General Manager, Corporate Services

Schedule A: Land Use Bylaw



TOWN OF STONY PLAIN

**LAND USE
BYLAW**

2735/LUO/26

Contents

PART 1 - Overview	1-1
1.1.0. Administration	1-1
1.2.0. Powers and Duties of the Development Authority.....	1-2
1.3.0. Development Permit Process.....	1-5
1.4.0. Enforcement Measures.....	1-11
PART 2 - Districts	2-1
2.1.0. Land Use Districts.....	2-1
2.2.0. R1 – Large Lot Detached Dwelling Residential District	2-2
2.3.0. R2 – Detached Dwelling Residential District.....	2-3
2.4.0. R3 – Residential Park District	2-4
2.5.0. R4 – Mixed Form Residential District.....	2-7
2.6.0. R5 – Small Lot Mixed-Form Residential District.....	2-9
2.7.0. R6 – Comprehensively Planned Residential District	2-11
2.8.0. R7 – Multi-Unit Building Residential District.....	2-16
2.9.0. R8 – High Density Residential District.....	2-19
2.10.0. C1 – Local Commercial District.....	2-22
2.11.0. C2 – General Commercial District	2-24
2.12.0. C3 – Central Mixed Use District	2-27
2.13.0. M1 – Business Industrial District.....	2-31
2.14.0. P1 – Parks District	2-33
2.15.0. P2 – Community Services District	2-34
2.16.0. P3 – Utility District	2-36
2.17.0. FD – Future Development District	2-37
PART 3 - General Regulations.....	3-1
3.1.0. Communal Amenity Space	3-1
3.2.0. Comprehensive Site Development and Servicing Plan	3-2
3.3.0. Landscaping.....	3-3
3.4.0. Lighting.....	3-5
3.5.0. Natural Conservation Areas	3-6
3.6.0. Sight Line Control	3-8
3.7.0. Solid Waste, Recycling and Organic Collection Facilities	3-10
3.8.0. Yards and Projections into Yards	3-11
3.9.0. Temporary Development.....	3-13
3.10.0. Proximity to a Railway Right of Way.....	3-14
3.11.0. Proximity to a Water Body or a Stream Course	3-15
3.12.0. Proximity to a Well Site, Pipeline or Utility Easement.....	3-17
3.13.0. Campgrounds	3-18
3.14.0. Cannabis Production and Distribution Facility.....	3-19
3.15.0. Cannabis Retail Sales.....	3-20
3.16.0. Earthworks	3-21
3.17.0. Major Home Occupations	3-22
3.18.0. Residential Sale Centres.....	3-23
3.19.0. Surveillance Suites	3-24
3.20.0. Accessory Development.....	3-25

3.21.0.	Accessory Dwelling.....	3-29
3.22.0.	Fencing	3-31
3.23.0.	Building Facades.....	3-33
3.24.0.	Relocation of Buildings.....	3-34
3.25.0.	Zero Lot Line Development.....	3-35
PART 4 - Parking & Access Regulations.....		4-1
4.1.0.	Parking Regulations.....	4-1
4.2.0.	Development Requirements for Parking Areas and Parking Facilities	4-3
4.3.0.	Off-Street Loading Regulations	4-6
4.4.0.	Queuing Requirements	4-7
4.5.0.	Driveways and Access to Roads and Lanes.....	4-8
PART 5 - Sign Regulations		5-1
5.1.0.	Regulations for a Development Permit for a Sign.....	5-1
5.2.0.	General Provisions for a Sign	5-3
5.3.0.	Enforcement Relating to Signs	5-11
5.4.0.	Sign Regulation by Type	5-12
PART 6 - Definitions.....		6-1
6.1.0.	List of Definitions	6-1
6.2.0.	Residential Uses	6-1
6.3.0.	Business Uses	6-2
6.4.0.	Community Service Uses.....	6-6
6.5.0.	Signs	6-7
6.6.0.	General Definitions	6-9

PART 1 - OVERVIEW

1.1.0. Administration

1.1.1. Title

This Bylaw may be referred to as the “Stony Plain Land Use Bylaw.”

1.1.2. Compliance with this Bylaw and Other Legislation

1. Nothing in this Bylaw releases an obligation of a person to comply with:
 - a. any federal, provincial, or municipal legislation;
 - b. any pertinent caveat, easement, instrument, agreement or other legal requirement; or
 - c. any standard, policy, procedure or other requirement of the Municipality.
2. Development may only be undertaken within the municipality where it complies with the provision of this Bylaw and:
 - a. a development permit application has been approved, a development permit issued and the Development is in accordance with the terms and conditions of a development permit issued pursuant to this Bylaw; or
 - b. the Development is exempt in Section 1.3.2.
3. The issuance of a development permit does not entitle a business to operate, which may require a license under a separate municipal bylaw pertaining to business licensing, nor does it entitle the construction of a building, which may require a building permit under a separate municipal bylaw pertaining to building permits.
4. Non-conforming uses and non-conforming buildings will be considered in accordance with and must comply with the *Municipal Government Act*.
5. Where a provision of this Bylaw requires interpretation as to its applicability to a subdivision or development, the Subdivision Authority or Development Authority will determine the meaning of that provision based on the information available.

1.1.3. Applications in Progress

1. All subdivision and development permit applications deemed complete prior to the effective date of this Bylaw will be processed and considered based on the provisions of the land use bylaw in effect when such an application was received, unless prior to a decision being made on the application, the Municipality receives a signed and written request from the applicant stating that the said subdivision or development permit application be processed and considered based on the provisions of this Bylaw.
2. All subdivision or development applications received on or after the effective date of this Bylaw will be processed and considered upon the provisions of this Bylaw.

1.2.0. Powers and Duties of the Development Authority

1.2.1. Establishment of the Development Authority

1. The Chief Administrative Officer of the Municipality is the Development Authority, with powers and duties as set out in this Bylaw and may in writing delegate any or all of these powers and duties specified in this Bylaw to a designated officer.
2. A designated officer may in writing be given the ability to further delegate any or all of the powers and duties they themselves have been given.

1.2.2. Decision on a Complete Development Permit Application

1. In making a decision on a complete development permit application for a Permitted Use, the Development Authority:
 - a. must approve the application if the proposed Development conforms with this Bylaw; or
 - b. may approve or refuse the application if the proposed Development does not conform to this Bylaw.
2. In making a decision on a complete development permit application for a Discretionary Use, the Development Authority:
 - a. may approve or refuse the application whether the proposed Development conforms or does not conform to this Bylaw.
3. In making a decision on a complete development permit application that may be approved or refused, the Development Authority will have regard to the circumstances and merits of the application including but not limited to the following:
 - a. the purpose and intent of any statutory or non-statutory plan or policy in effect;
 - b. the purpose and intent of the applicable land use district;
 - c. the design, character and appearance of the proposed Development and, in particular, whether it is compatible with and complementary to the surrounding properties;
 - d. servicing requirements;
 - e. access and transportation requirements;
 - f. vehicle and pedestrian circulation within the parcel;
 - g. additional information or documentation not provided by the applicant that the Development Authority considered necessary to review to make a decision on the application; and
 - h. the impact of the proposed use on surrounding properties by a nuisance factor including but not limited to noise, smoke, dust, odour, vibration or glare, or any combination of these factors.
4. In making a decision to refuse a complete development permit application, the Development Authority must provide a reason for such a refusal of an application as part of the written decision.
5. In cases where an activity meets more than one use definition, the Development Authority will deem the appropriate principal use definition.

1.2.3. Development Permit Conditions

1. The Development Authority may impose conditions of approval on any development permit based on the following:
 - a. the application of land use planning considerations or principles to the circumstances of a proposed Development; and
 - b. to ensure compliance with any provision of this Bylaw.

2. The Development Authority may impose any of the following conditions on the approval of a development permit application:
 - a. to govern the location of any building on a Lot; and
 - b. to regulate and limit the time within which a Development or any part of it is to be completed.
3. The Development Authority may impose, as a condition of approval on a development permit, a specified time limit on the duration of Development approval in the case of a development permit for a Discretionary Use or a Permitted Use approved with a variance or condition, and has the discretion to extend that time if the application is made before the expiry date of the development permit in accordance with Section 3.9.1. of this Bylaw.
4. The Development Authority may impose, as a condition of approval on a development permit, a requirement that the applicant enter into an agreement with the Municipality, to provide for any matter or thing relevant to the Development or to the relationship between the applicant and the Municipality resulting from or relating to the Development, including without limitation any matter or thing described in the *Municipal Government Act*, which includes:
 - a. to construct or pay for the construction of a road required to give access to the Development;
 - b. to construct or pay for the construction of both or either of:
 - i. a pedestrian walkway system to serve the Development, or
 - ii. pedestrian walkways to connect the pedestrian walkway system serving the Development with a pedestrian walkway system that serves or is proposed to serve an Adjacent Development,
 - c. to install or pay for the installation of public utilities, other than telecommunications systems or works, which are necessary to serve the Development;
 - d. to construct or pay for the construction both or either of:
 - i. off-street or other parking facilities, or
 - ii. loading and unloading facilities;
 - e. to pay any pertinent development charges, which may include an off-site levy or redevelopment levy; and
 - f. to provide security to ensure that the terms of such an agreement are carried out.
5. Where an application for a development permit is approved with a condition requiring the applicant or landowner to enter into an agreement with the Municipality as described in Section 1.2.3.4.:
 - a. such an agreement may be protected by caveat registered by the Municipality in accordance with the *Municipal Government Act*;
 - b. the Municipality may require the payment of development charges, which may include an off-site levy, and security for the completion of off-site work related to the Development; and
 - c. the approved plans and specifications must not be changed or modified without written authorization from the Development Authority and all work must be done in accordance with the approved plans.
6. The Development Authority may impose, as a condition of approval on a development permit, a requirement to provide security, in an amount as determined by Council, prior to the commencement of Development to ensure the Development is in accordance with the terms and conditions of a development permit issued pursuant to this Bylaw, which will be released upon request once all the terms and conditions of the development permit are met.

7. The Development Authority may impose, as a condition of approval on a development permit for a multi-unit residential, commercial, industrial, community and park use, or a Development requiring a servicing plan, a requirement to provide:
 - a. on-site engineering design drawings signed and stamped by a professional engineer in the province of Alberta prior to the commencement of Development; and
 - b. on-site engineering record drawings signed and stamped by a professional engineer in the province of Alberta once all the terms and conditions of the development permit are met.

1.2.4. Development Permit Variance

1. The Development Authority may vary any regulation of this Bylaw and issue a development permit even though the proposed Development does not comply with one or more regulations of this Bylaw or is a non-conforming building if the proposed Development:
 - a. conforms to the use prescribed for that land or building in this Bylaw; and
 - b. would not unduly interfere with the amenities of the neighbourhood or materially interfere with or affect the use, enjoyment or value of neighbouring parcels of land.
2. The Development Authority may grant a variance if:
 - a. the variance is mainly to accommodate a physical feature that is specific to the Site, building or sign to which it applies, which is not shared by a significant number of other Sites, buildings or signs in the municipality;
 - b. the variance is a reasonable deviation from the applicable Development regulation or other requirement of this Bylaw, which is needed to accommodate the proposed Development; or
 - c. the variance is for a Development that does not comply in terms of a Yard Setback, provided that:
 - i. the Development does not encroach on any easement, unless an agreement has been granted in respect of it;
 - ii. the Development does not encroach on any Lot Line; and
 - iii. a drainage plan indicates the Development will not create drainage problems.
3. Any variance granted must be expressed as part of the development permit approval and must have consideration for 1.2.2.3.

1.3.0. Development Permit Process

1.3.1. Requirements for a Development Permit

1. Except as provided in Section 1.3.2., no person will commence any Development unless a development permit has been approved and issued in respect thereof.
2. Where any on-site service or improvement, or any off-site local improvement is required to service a proposed Development, a person must not begin the excavation for the foundation nor commence Development until either:
 - a. a development agreement has been agreed to; or
 - b. a development permit has been issued for Site preparation work.
3. No development permit will be issued for a Development to be served by private sewer and water systems until the systems have been approved by the appropriate municipal, provincial and federal departments.
4. A development permit will not be issued for a Development that includes a building proposed to extend over more than one Lot until the Lots the building is proposed to extend over are consolidated, unless:
 - a. the building is divided on or along one or more Lot Lines into two or more separate sections that have been designed with sufficient separation between them based on the intended uses of each section; and
 - b. separate servicing is provided to each section of the building that is divided by a Lot Line via servicing contained solely within each Lot a section of the building is contained within.
5. An application for a development permit is not complete, where subdivision is required, until the appropriate subdivision is registered pursuant to the subdivision regulations.
6. Notwithstanding Section 1.3.1.5., the Development Authority may approve an application for a development permit for a show home subsequent to an approved show home agreement for the appropriate Subdivision area in which the show home is to be located.
7. A development permit application may not contain a permitted use and a discretionary use.

1.3.2. Exemption from a Development Permit

The following Developments do not require a development permit provided that the proposed Development complies with all applicable provisions of this Bylaw:

1. a change of use of a Site to a Permitted Use where a development permit has been previously issued for that use and remains valid;
2. a change of use of a Site to a Permitted Use unless the change of use is for Automotive and Recreation Vehicles Sales and Service, Bar, Campground, Car Wash, Cemetery, Earthworks, Gas Bar, Heavy Vehicle and Equipment Wash Facility, Hospital, Hotel, Motel, Private Club, Recreation Facility, Recycling Depot, Religious Assembly or Residential Sale Centre;
3. alteration, renovation, maintenance or repair of any building provided that the work does not include structural alterations or an increase to the gross floor area;
4. a General Accessory Development with a gross floor area of 10.0 m² or less;
5. the construction, maintenance and repair of public works, services and utilities carried out by, or on behalf, of the Municipality or any public utility;
6. the erection or placement of a temporary building, not to be used for residential purposes, which may include a construction trailer or shipping container, the sole purpose of which is incidental to the erection of a building for which a development permit has been granted, excluding Residential Sale Centres, provided the temporary building is removed within 30 days of substantial completion of the principal building or as determined by the Development Authority;

7. a temporary event such as a market, special function tent, or outdoor amusement park placed or erected for less than 7 days;
8. an emergency measure;
9. the erection of a Fence or gate that conforms to Section 3.22.;
10. landscaping where the proposed grades will not adversely affect the subject or Adjacent properties;
11. a pergola, trellis, arbour, play equipment or seasonal gazebo;
12. a Privacy Wall 2.4 m or less in height;
13. a solid waste, recycling and organic collection facility and associated enclosure;
14. a seasonal aboveground Swimming Pool that conforms to Section 3.20.1.8.;
15. a pathway such as a sidewalk or trail;
16. a walkways not attached to driveways associated with a residence;
17. a satellite dish or antenna;
18. a solar panel mounted to a building;
19. a Community Garden;
20. a Deck, landing or patio that is 0.60 m or less above grade in height and does not have a roof;
21. the construction, maintenance and repair of a retaining wall less than 0.60 m in height;
22. residential interior renovations, excluding an Accessory Dwelling located in a basement;
23. site stripping, grading or excavation that is part of a Development for which a development permit has been issued or a development agreement entered into with the Municipality;
24. a shipping container that conforms to Section 3.20.1.7.;
25. a Minor Home Occupation;
26. a Family Day Home; and
27. a Planning Bylaw Notice Sign.

1.3.3. Application Requirements for a Development Permit

1. An application for a development permit must be made to the Development Authority and requires the following to be considered complete:
 - a. required application fees, as determined by Council;
 - b. a completed development permit application form;
 - c. a site plan;
 - d. documentation showing building elevations and floor plan layouts, where applicable;
 - e. an abandoned well search;
 - f. the location of any existing or proposed wells, septic tanks, disposal fields, culverts or crossings;
 - g. other information as the Development Authority may reasonably require to ensure compliance with the provisions of this Bylaw, which may include:
 - i. a site grading plan;
 - ii. a landscaping plan must be provided where required by Section 3.3.1.;
 - iii. a site servicing plan;
 - iv. soil testing or geotechnical report;
 - v. an environmental assessment;
 - vi. an engineering study for the use or impact upon municipally owned and operated utility systems;
 - vii. photographic documentation showing the Site in its current condition;
 - viii. visual display of how the form, mass and character of the proposed Development will relate to neighbouring Developments;

- ix. a noise evaluation study;
 - x. a parking, access management or transportation study;
 - xi. proof of a roadside development permit from Alberta Transportation and Economic Corridors;
 - xii. irrevocable letters of credit or cash from the developer to secure performance of any of the conditions of a development permit or development agreement;
 - xiii. a current land title, along with copies of any caveat, right of way, easement or restrictive covenant registered on the title;
 - xiv. a current corporate registry search; and
 - xv. any other information required by the Development Authority to determine how a proposed Development may affect land use in the area.
2. Documentation required as part of a development permit application must be provided to the satisfaction of the Development Authority.
 3. Any plan or documentation provided as part of a development permit application must:
 - a. be dimensioned in metre;
 - b. drawn to scale;
 - c. be legible; and
 - d. contain property and location information relevant to the type of plan or documentation including but not limited to:
 - i. a north arrow;
 - ii. any legal land description;
 - iii. municipal addressing;
 - iv. the scale of the plan;
 - v. the location and dimensions of any Lot Line; and
 - vi. any registered easement or right of way.
 4. In addition to the relevant requirements in Section 1.3.3.3., a site plan must identify:
 - a. the location and dimensions of any existing and proposed building or structure, including an outline of the roof overhang in relation to any Lot Line;
 - b. the location and dimensions of any existing and proposed parking stall, drive aisle, loading area or entrance or exit Abutting any public road;
 - c. turning radius details to accommodate the maneuvering of a fire fighting apparatus and any commercial vehicle, where applicable;
 - d. the location and name of any Abutting road;
 - e. existing and proposed surface drainage;
 - f. the location of any light standard, catch basin, utility pole, hydrant, utility box, other utility feature or community mailbox in proximity to the Site; and
 - g. other information as deemed necessary by the Development Authority;
 5. In addition to the relevant requirements in Section 1.3.3.3., a site grading plan must:
 - a. be designed by an Alberta land surveyor, engineer or registered architect; and
 - b. include:
 - i. any existing or proposed surface elevation, contour or surface grade of the Lot at any lot line corners, at an interval along any lot line or adjacent to any foundation wall or concrete slab-on-grade for each existing or proposed;
 - ii. the existing or proposed direction of surface drainage flow, indicated by arrows;
 - iii. any existing or proposed surface conditions including but not limited to sod, asphalt, concrete and gravel;
 - iv. any provision necessary to accommodate an overland flow from an adjacent undeveloped land;

- v. the location and dimensions of any existing and proposed private storm drainage system; and
 - vi. any unusual or special requirement information based on any associated geotechnical report or soil testing.
6. In addition to the relevant requirements in Section 1.3.3.3., a site servicing plan must:
- a. be submitted as an engineering design drawing or set of drawings;
 - b. be signed and stamped by a professional engineer in the province of Alberta; and
 - c. include:
 - i. the location of any existing and proposed wells, septic tanks, disposal fields, culverts and crossings;
 - ii. location and elevations of water mains, hydrants, valves, sanitary sewer mains and manholes, storm water sewer mains and manholes, and catch basins;
 - iii. location of any existing underground infrastructure including water mains and servicing, sanitary mains and servicing, and storm pipes;
 - iv. location and type of shallow utilities including overhead and underground, which may include power lines, gas lines and telecommunications; and
 - v. pipe size, length, slope and material for all deep utilities including any anticipated water demands and sanitary flow rates for the Site expressed in l/s or m³/s tabulated in the legend as required.

1.3.4. Development Permit Application Status

1. The Development Authority may deem a development permit application incomplete where the information required by Section 1.3.3. has not been supplied or where, the quality of the material supplied is inadequate to properly evaluate the application.
2. A development permit application may be deemed incomplete where it does not comply with Section 1.3.1.5. of this Bylaw.
3. Written notice of a development permit application deemed complete or incomplete and notice of decision of a development permit must be given in accordance with the *Municipal Government Act*.
4. The notice of an application deemed incomplete must provide a deadline as determined by the Development Authority to provide the information required to complete the application unless the Development Authority and the applicant agree to an extension in writing.
5. Written notice must be given using the following methods within 24 hours of the notice being issued:
 - a. regular mail; or
 - b. electronic mail, if the applicant has provided an email address on their application and has given consent to receive correspondence by electronic mail.
6. An agreement for an extension to a deadline pertaining to a deemed incomplete notice or decision must be:
 - a. prepared by the Development Authority;
 - b. signed by both parties; and
 - c. specify the agreed upon date for the extension.

1.3.5. Waiver of Development Permit Application Requirements

1. The Development Authority may accept an application and make a decision without all of the information required by Section 1.3.3., if a decision on the application can be properly made without such information.

1.3.6. Notice of Decision

1. The decision of the Development Authority on an application for a development permit must be given to the applicant in a form determined by the Municipality.
2. If a Development Authority refuses an application for a development permit, the notice of decision must contain the reasons for the refusal.
3. Notice of a development approval for a discretionary use or a variance issued by the Development Authority must:
 - a. indicate the date the development permit was approved and that an appeal may be made by the person applying for the permit or a person affected by the decision;
 - b. be mailed to all landowners in the town of Stony Plain:
 - i. within 30.0 m of the subject site or lot;
 - ii. whose property the Development Authority believes may be affected by the decision; and
 - c. be published on the website of the Municipality.
4. Where a lot in a municipality other than the town of Stony Plain is within 30.0 m of the subject site or lot written notification of the approved development will only be mailed to that municipal office.
5. During any mail delivery stoppage, notice of a development approval for a discretionary use or a variance issued by the Development Authority will be published on the website of the Municipality.

1.3.7. Issuance and Validity of a Development Permit

1. The Development Authority must issue a development permit to the applicant on the day the decision to approve an application is made.
2. A development permit for a Discretionary Use or for a Permitted Use for which a variance has been granted comes into force and effect:
 - a. only after the time for an appeal to the appropriate appeal body has expired; or
 - b. if an appeal has been filed, once a decision has been rendered in writing by the appropriate appeal body in favour of the issuance of the development permit subject to any variance or change to any condition of approval directed by the appropriate appeal body.
3. In accordance with the *Municipal Government Act* no appeal lies in respect of the issuance of a development permit for a Permitted Use unless the provisions of a land use bylaw were relaxed, varied or misinterpreted.
4. Any work undertaken prior to the expiry of the appeal period of a development permit is at the risk of the landowner.
5. If the Development authorized by a development permit has not commenced significantly, within 12 months from the date of its issue, or date of decision of the appropriate appeal body upon appeal, the development permit ceases to be in effect unless an extension to this period has been granted by the Development Authority in accordance with Section 1.3.9. of this Bylaw.

1.3.8. Re-application for a Development Permit

1. Where an application for a development permit has been refused by the Development Authority, or Council in the case of a direct control district, or has been refused on appeal to the appropriate appeal body, the Development Authority at its discretion, may refuse to accept another application on the same parcel of land, for the same or similar use by the same or any other applicant for six months following the date of the decision of refusal.

1.3.9. Expiry of a Development Permit

1. A development permit expires one year from the date of issuance unless Development has commenced on the Site.
2. Development is considered to commence:
 - a. once excavation or Site preparation in anticipation of construction for the approved development permit occurs, which does not include fencing, erecting signs or obtaining required information for the Development of the Site that includes but is not limited to an engineering study, geotechnical work, a Site survey, soil analysis, an environmental assessment or combination of these or other works; or
 - b. for a development permit limited to a change of use when the new use is in effect.
3. Once Development has commenced, a Development must be completed within two years of permit issuance or the permit expires.
4. Where a development permit is issued for a Site where any other development permit has been issued, any previous development permit will expire if the physical aspects of the Development conflict or where a Development cannot occur simultaneously upon the Site.
5. The Development Authority may grant an extension to the expiry date of a development permit, considering the following:
 - a. an extension request must be submitted to the Development Authority by the permit holder in writing;
 - b. the maximum length of an extension is one year from the date that a development permit would expire;
 - c. only one extension may be granted;
 - d. an extension for a development permit expires one year after the date of the extension unless Development has commenced on the Site; and
 - e. the extension may not change the original development permit issued or any of its conditions except to extend any date which causes a permit to expire.

1.3.10. Suspension or Cancellation of a Development Permit

1. The Development Authority may suspend or cancel a development permit following its issuance if the Development Authority determines that:
 - a. the application contains a misrepresentation;
 - b. the fees have not been paid or a cheque is returned not sufficient funds;
 - c. the development permit was issued in error;
 - d. facts concerning the application or the proposed Development were not disclosed, which should have been disclosed at the time the application was considered; or
 - e. any of the conditions imposed in the development permit have not been complied with.
2. If the Development Authority suspends or cancels a development permit, the Development Authority must provide a written notification to the applicant with the reason for the suspension or cancellation.
3. Upon receipt of written notice of suspension or cancellation, the applicant must cease all Development and activities for which the development permit was issued.

1.3.11. Application Referral for a Development Permit

1. The Development Authority will refer a development permit application in accordance with the *Municipal Government Act* or any of its regulations.

1.4.0. Enforcement Measures

1.4.1. Enforcement

1. A person must comply with a development permit or the plans and conditions forming part of the permit and may not make use of the land in a manner contrary to the provisions of this Bylaw.

1.4.2. General Offences

1. An offence is committed when:
 - a. any landowner, lessee or occupant of the land, or a building or a structure thereon, contravenes any provisions of this Bylaw;
 - b. any landowner, contractor, worker or other person undertakes a Development for which a development permit is required but has not been issued under this Bylaw, or is in contravention of a condition of a development permit issued under this Bylaw; or
 - c. any landowner, lessee or occupant of the land, or a building or a structure thereon that contravenes an order under Section 1.4.6.

1.4.3. Right of Entry and Authority to Enforce

1. For the purposes described in the *Municipal Government Act*, an authorized person may enter into or upon any land or building within the municipal boundary to ensure compliance with this Bylaw, where:
 - a. reasonable notice (48 hours) has been given to the landowner or occupant of the property; and
 - b. the property is entered at reasonable hours (generally between 8:00 a.m. to 10:00 p.m.).

1.4.4. Contravention

1. When an offence has been or is being committed, the Development Authority may:
 - a. suspend or revoke a development permit which has not been complied with; and
 - b. issue an order.

1.4.5. Violation Tickets

1. A peace officer may issue a violation ticket to any person alleged to have breached any provision of this Bylaw.
2. A violation ticket must be served upon the alleged offender personally or by registered mail.
3. A violation ticket must specify:
 - a. the amount of the penalty based on a first, second or third offence;
 - b. the date and time by which the fine is payable to the Municipality, which must be within 21 days from the date of issue of the fine; and
 - c. the date and time by which the property must be brought into conformity with this Bylaw.
4. The fines for an offence against this Bylaw will be subject to the minimum penalty amount, as specified in Table 1.4.5.
5. If a person is convicted twice of the same offence of this Bylaw within a 12-month period, the minimum penalty for the second conviction will be double the minimum penalty of the first offence.
6. If a person is convicted three or more times of the same offence with respect to this Bylaw within a 12-month period, the minimum penalty for the third and subsequent convictions will be three times the minimum penalty of the first offence.

Table 1.4.5. - Minimum Penalties	
Offences	Minimum penalty
Failure to obtain a development permit	\$500
Failure to comply with development permit conditions	\$500
Failure to comply with regulations in residential districts, except the R8 – High Density Residential District	\$250
Failure to comply with regulations in all other districts, including the R8 – High Density Residential District	\$1000
Failure to obtain a development permit for a sign when required	\$200
Failure to comply with development permit conditions for a sign when required or failure to comply with regulations regarding a sign when a development permit is not required	\$200

7. If payment is made within the time limit, then such payment will be accepted in lieu of prosecution for the offence.
8. If a person who has been served with a violation ticket fails to pay the fine specified therein, then the right of the alleged offender to settle the alleged offence without a court appearance will no longer apply and prosecution for the alleged offence will proceed.
9. If the person who was served with the violation ticket is thereafter prosecuted and convicted of the offence specified in the violation ticket, that person is liable to a fine of not more than \$10 000, or to imprisonment for a period not exceeding one year or to both fine and imprisonment.

1.4.6. Orders

1. When issuing an order, the written notice must order the landowner, the person in possession of the land or building, the person responsible for the contravention, or all of them to:
 - a. stop the Development or use of the land or building that is contrary to this Bylaw;
 - b. demolish, remove or bring the Development into compliance with this Bylaw;
 - c. carry out any other actions required by the notice so that the Development complies with the provisions of this Bylaw;
 - d. complete the actions in the notice before the date set in the notice; and
 - e. provide the option to register an appeal to the appropriate appeal body.
2. If the person fails or refuses to comply with the order or an order of the appropriate appeal body, the Development Authority may:
 - a. obtain an injunction from an Alberta Court to enforce the order and this Bylaw;
 - b. register a caveat under the *Land Titles Act* in respect of the order;
 - c. enter into or upon the land or building and take any action necessary to carry out the order in accordance with the *Municipal Government Act*; and
 - d. the cost of action or measure will be charged to the registered landowner and collected, in like manner as taxes owing against a property.

PART 2 - DISTRICTS

2.1.0. Land Use Districts

1. The municipality is divided into land use districts and the boundaries of each and every district are delineated on the Land Use Districts Map, which forms part of this Bylaw.
2. Where uncertainty arises as to the precise location of the boundary of any district as shown on the Land Use Districts Map, the following rules will apply:
 - a. Where a district boundary appears to follow a Lot boundary, a municipal boundary, a center line of a railway or road right of way, it will be deemed to do so; otherwise, it will be determined on the basis of the scale of the map.
 - b. Where a land use district has been established in accordance with a proposed subdivision of land, the district must be understood to conform to the certificate of title or the plan of survey when registered in a Land Titles Office; however, prior to the registration, the district boundary must be determined on the basis of the scale of the map.
3. The district regulations of this Bylaw do not apply to roads, lanes, other public thoroughfares, or public and private utilities and their associated structures.

2.2.0. R1 – Large Lot Detached Dwelling Residential District

2.2.1. Purpose

This district provides for Detached Dwellings on large Lots with the possibility of an Accessory Dwelling.

2.2.2. Permitted Uses

Accessory Dwelling
Detached Dwelling
Earthworks
General Accessory Development
Park
Residential Sale Centre

2.2.3. Discretionary Uses

Bed and Breakfast
Major Home Occupation
Religious Assembly
Residential Vehicle Storage

2.2.4. Subdivision Regulations

1. **Density (maximum):**
 - a. 2 Dwelling Units per Lot, inclusive of an Accessory Dwelling
2. **Lot Depth (minimum):**
 - a. 33.0 m
3. **Lot Width (minimum):**
 - a. 12.0 m for an internal Lot; and
 - b. 13.7 m for a Corner Lot

2.2.5. Development Regulations

1. **Lot Coverage (maximum):**
 - a. 50%
2. **Front and Flankage Yard Setbacks (minimum):**
 - a. 4.0 m to the principal building from the Front Lot Line
 - b. 3.0 m to the principal building from a Flankage Lot Line
 - c. 6.0 m to an attached garage from the Front Lot Line or Flankage Lot Line
3. **Rear Yard Setbacks (minimum):**
 - a. 7.5 m to the principal building
 - b. 6.0 m to an attached garage
4. **Side Yard Setbacks (minimum):**
 - a. 1.5 m to the principal building where the Lot Width is 15.0 m or greater
 - b. 1.2 m to the principal building where the Lot Width is less than 15.0 m
5. **Building Height (maximum):**
 - a. 12.0 m

2.3.0. R2 – Detached Dwelling Residential District

2.3.1. Purpose

This district provides for Detached Dwellings with a variety of Lot shape options, such as shallow-wide Lots, and the possibility of an Accessory Dwelling.

2.3.2. Permitted Uses

Accessory Dwelling
Detached Dwelling
Earthworks
General Accessory Development
Park
Residential Sale Centre

2.3.3. Discretionary Uses

Bed and Breakfast
Major Home Occupation
Religious Assembly
Residential Vehicle Storage

2.3.4. Subdivision Regulations

1. **Density (maximum):**
 - a. 2 Dwelling Units per Lot, inclusive of an Accessory Dwelling
2. **Lot Width (minimum):**
 - a. 9.7 m for an internal Lot
 - a. 11.2 m for a Corner Lot
3. **Lot Area (minimum):**
 - a. 315 m² for an internal Lot
 - b. 365 m² for a Corner Lot

2.3.5. Development Regulations

1. **Lot Coverage (maximum):**
 - a. 50%
2. **Front and Flankage Yard Setbacks (minimum):**
 - a. 4.0 m to the principal building from the Front Lot Line
 - b. 2.4 m to the principal building from a Flankage Lot Line
 - c. 6.0 m to an attached garage from the Front Lot Line or Flankage Lot Line
3. **Rear Yard Setbacks (minimum):**
 - a. 7.5 m to the principal building
 - b. 6.0 m to an attached garage
4. **Side Yard Setbacks (minimum):**
 - a. 1.2 m to the principal building
5. **Building Height (maximum):**
 - a. 12.0 m

2.4.0. R3 – Residential Park District

2.4.1. Purpose

This district provides for unique forms of low density residential Development composed primarily of Detached Dwellings often in a community living setting. Two sets of regulation options are provided to accommodate different development scales, one of which requires a finer-scale of subdivision than the other.

2.4.2. Permitted Uses

Detached Dwelling
Earthworks
General Accessory Development
Park
Residential Sale Centre

2.4.3. Discretionary Uses

Bed and Breakfast
Community Facility
Child Care Service
Indoor Sales and Service
Major Home Occupation
Religious Assembly
Residential Vehicle Storage

2.4.4. General Regulations

1. Community and Business Uses

- a. A Child Care Service or Community Facility use is only allowed on Sites that follow the requirements of Option B: A Residential Park

Option A: A Residential Park Subdivision

This option allows for individually owned Lots for residential park Detached Dwellings that Abut a public road in a typical residential subdivision form.

2.4.5. Subdivision Regulations for a Residential Park Subdivision

1. **Density (maximum):**
 - a. 1 Detached Dwelling per Lot
2. **Lot Width (minimum):**
 - a. 12.0 m for an internal Lot
 - b. 13.7 m for a Corner Lot
3. **Lot Depth (minimum):**
 - a. 33.0 m

2.4.6. Development Regulations for a Residential Park Subdivision

1. **Lot Coverage (maximum):**
 - a. 50%
2. **Front and Flankage Yard Setbacks (minimum):**
 - a. 6.0 m to the principal building from the Front Lot Line or Flankage Lot Line where any parking spaces are located between the principal building and the Front Lot Line or

- Flankage Lot Line, except that the Setback may be reduced to 3.0 m provided that there is 6.0 m between the principal building and the sidewalk or curb, whichever is closer
- b. 3.0 m to the principal building from the Front Lot Line or Flankage Lot Line for all other instances
 - c. 6.0 m to the front of a garage from a Front Lot Line or Flankage Lot Line, except that the Setback may be reduced to 3.0 m provided that there is 6.0 m between the front of the garage and the sidewalk or curb, whichever is closer
3. **Rear Yard Setbacks (minimum):**
 - a. 3.0 m
 4. **Side Yard Setbacks (minimum):**
 - a. 1.5 m
 5. **Building Height (maximum):**
 - a. 8.0 m

Option B: A Residential Park

This option provides regulations that allow for a residential park developed within a single large Lot where each dwelling accesses public roads via a private road or network of private roads.

2.4.7. Subdivision Regulations for a Residential Park

1. **Lot Area (minimum):**
 - a. 5.0 ha

2.4.8. Development Regulations for a Residential Park

1. **Comprehensive Site Development and Servicing Plan**
 - a. A comprehensive site development and servicing plan must be accepted and approved by the Development Authority prior to the issuance of any development permit
2. **Density (maximum):**
 - a. 24 Dwelling Units per ha
3. **Lot Coverage (maximum):**
 - a. 50%
4. **Building Setback from Private Roads and Walkways (minimum):**
 - a. 6.0 m to the building from the private road or walkway where any parking spaces are located between the building and the private road or walkway
 - b. 3.0 m to the building from the private road or walkway for all other instances
5. **Building Setback from Public Road Rights of Way (minimum):**
 - a. 3.0 m
6. **Building Setback between Buildings containing a Dwelling (minimum):**
 - a. 3.0 m
7. **Building Setback from a Building not containing a Dwelling (minimum):**
 - a. 2.0 m
8. **Building Setback from Property Lines (minimum):**
 - a. 1.5 m

9. **Yard Standards**

- a. Each dwelling must have its own contiguous defined yard space that is:
 - i. Adjacent to at least one side of the dwelling; and
 - ii. a minimum of 100 m² in area where no distance within the perimeter is less than 3.2 m.

2.5.0. R4 – Mixed Form Residential District

2.5.1. Purpose

This district provides for Detached Dwellings, Semi-Detached Dwellings, Duplex Dwellings and three to four unit Row House Dwellings with a variety of Lot shape options, such as shallow-wide Lots, and the possibility of an Accessory Dwelling.

2.5.2. Permitted Uses

Accessory Dwelling
Detached Dwelling
Duplex Dwelling
Earthworks
General Accessory Development
Park
Residential Sale Centre
Row House Dwelling
Semi-Detached Dwelling

2.5.3. Discretionary Uses

Bed and Breakfast
Major Home Occupation
Religious Assembly
Residential Vehicle Storage

2.5.4. Subdivision Regulations

1. **Density (maximum):**
 - a. 2 Dwelling Units per Lot, inclusive of an Accessory Dwelling
2. **Dwellings in a Row House (maximum):**
 - a. 4
3. **Lot Access for Internal Row House Dwelling Units**
 - a. Internal Row House Dwelling units must have direct access available to their Rear Yards from public land such as municipal reserve, environmental reserve, public utility lot, lane or other road right of way, or indirectly via an access easement or other mechanism that will ensure perpetual access is available to their Rear Yards from public land
4. **Lot Width for Rear Lane Access (minimum):**
 - a. Detached Dwelling – 9.1 m
 - b. Duplex Dwelling – 9.1 m
 - c. Semi-Detached Dwelling – 7.9 m
 - d. Row House Dwelling internal unit – 6.7 m
 - e. Row House Dwelling end unit – 7.9 m
 - f. Corner Lot requires 1.5 m of additional Lot Width
5. **Lot Area for Rear Lane Access (minimum):**
 - a. Detached Dwelling – 295 m²
 - b. Duplex Dwelling – 295 m²
 - c. Semi-Detached Dwelling – 255 m²
 - d. Row House Dwelling internal unit – 220 m²
 - e. Row House Dwelling end unit – 255 m²

- f. Corner Lot requires 50.0 m² of additional Lot Area
6. **Lot Width for Non-Rear Lane Access (minimum):**
 - a. Detached Dwelling – 9.7 m
 - b. Duplex Dwelling – 9.7 m
 - c. Semi-Detached Dwelling – 8.5 m
 - d. Row House Dwelling internal unit – 7.3 m
 - e. Row House Dwelling end unit – 8.5 m
 - f. Corner Lot requires 1.5 m of additional Lot Width
 7. **Lot Area for Non-Rear Lane Access (minimum):**
 - a. Detached Dwelling – 315 m²
 - b. Duplex Dwelling – 315 m²
 - c. Semi-Detached Dwelling – 275 m²
 - d. Row House Dwelling internal unit – 235 m²
 - e. Row House Dwelling end unit – 275 m²
 - f. Corner Lot requires 50.0 m² of additional Lot Area

2.5.5. Development Regulations

1. **Lot Coverage (maximum):**
 - a. 60% for an internal unit Row House Dwelling
 - b. 50% for any other dwelling
2. **Dwellings in a Row House (maximum):**
 - a. 4
3. **Front and Flankage Yard Setbacks (minimum):**
 - a. 4.0 m to the principal building from the Front Lot Line
 - b. 2.4 m to the principal building from a Flankage Lot Line
 - c. 6.0 m to an attached garage from the Front Lot Line or Flankage Lot Line
4. **Rear Yard Setbacks (minimum):**
 - a. 7.5 m to the principal building
 - b. 6.0 m to an attached garage
5. **Side Yard Setbacks (minimum):**
 - a. 1.2 m to the principal building
6. **Building Height (maximum):**
 - a. 12.0 m

2.6.0. R5 – Small Lot Mixed-Form Residential District

2.6.1. Purpose

This district provides for Detached Dwellings, Semi-Detached Dwellings and three- to six-unit Row House Dwellings on compact Lots generally served by lanes that allow for a variety of Lot shape options, such as shallow-wide Lots.

2.6.2. Permitted Uses

Detached Dwelling
Earthworks
General Accessory Development
Park
Residential Sale Centre
Row House Dwelling
Semi-Detached Dwelling

2.6.3. Discretionary Uses

Bed and Breakfast
Major Home Occupation
Religious Assembly
Residential Vehicle Storage

2.6.4. Subdivision Regulations

1. **Density (maximum):**
 - a. 1 Detached Dwelling per Lot
2. **Dwellings in a Row House (maximum):**
 - a. 6
3. **Lot Access for Internal Row House Dwelling Units**
 - a. Internal Row House Dwelling units must have direct access available to their Rear Yards from public land such as a municipal reserve, environmental reserve, public utility lot, lane or other road right of way, or indirectly via an access easement or other mechanism that will ensure perpetual access is available to their Rear Yards from public land
4. **Lot Width (minimum):**
 - a. Detached Dwelling – 7.2 m
 - b. Semi-Detached Dwelling – 6.0 m
 - c. Row House Dwelling internal unit – 4.3 m
 - d. Row House Dwelling end unit – 5.5 m
 - e. Corner Lot requires 1.5 m of additional Lot Width
5. **Lot Area (minimum):**
 - a. Detached Dwelling – 235 m²
 - b. Semi-Detached Dwelling – 195 m²
 - c. Row House Dwelling internal unit – 140 m²
 - d. Row House Dwelling end unit – 180 m²
 - e. Corner Lot requires 50.0 m² of additional Lot Area

2.6.5. Development Regulations

1. **Lot Coverage (maximum):**
 - a. 65% for an internal Row House Dwelling unit
 - b. 50% for any other dwelling
2. **Dwellings in a Row House (maximum):**
 - a. 6
3. **Front and Flankage Yard Setbacks (minimum):**
 - a. 4.0 m to the principal building from the Front Lot Line if the Lot does not have lane access
 - b. 3.0 m to the principal building from the Front Lot Line if the Lot has lane access
 - c. 2.4 m to the principal building from a Flankage Lot Line
 - d. 6.0 m to an attached garage from a Front Lot Line or Flankage Lot Line
4. **Rear Yard Setbacks (minimum):**
 - a. 7.5 m to the principal building
 - b. 6.0 m to an attached garage
5. **Side Yard Setbacks (minimum):**
 - a. 1.2 m
6. **Building Height (maximum):**
 - a. 12.0 m

2.7.0. R6 – Comprehensively Planned Residential District

2.7.1. Purpose

This district provides for a comprehensively planned medium density residential Development. Two different sets of regulation options are provided to accommodate different Development scales, one of which requires a finer-scale of subdivision than the other.

2.7.2. Permitted Uses

Detached Dwelling
Duplex Dwelling
Earthworks
General Accessory Development
Multi-Unit Dwelling
Park
Residential Sale Centre
Row House Dwelling
Semi-Detached Dwelling
Supportive Living Facility

2.7.3. Discretionary Uses

Long Term Care Facility
Major Home Occupation
Religious Assembly
Residential Vehicle Storage

2.7.4. General Regulations

1. Duplex and Multi-unit Dwelling Uses

- a. A Duplex or Multi-Unit Dwelling use is only allowed on Sites that follow the requirements of Option A: Comprehensive Planned Site

2. Lot Access for Internal Row House Dwelling Units

- a. Internal Row House Dwelling units must have direct access available to their Rear Yards from public land such as a municipal reserve, environmental reserve, public utility lot, lane or other road right of way, or indirectly via an access easement or other mechanism that will ensure perpetual access is available to their Rear Yards from public land

3. Row House and Multi-unit Dwelling Uses

- a. A Row House Dwelling or Multi-Unit Dwelling use is restricted from portions of Plan 132 3523 Block B Lot 2, Plan 152 2794 Block 4 Lot 105 and Plan 132 3523 Block 7 Lot 41MR as shown in Figure 2.7.4.

2. **Density (maximum):**
 - a. 60 Dwelling Units per ha
3. **Density (minimum):**
 - b. 20 Dwelling Units per ha
4. **Lot Coverage (maximum):**
 - a. 50%
5. **Separation between Buildings within a Development (minimum):**
 - a. 6.0 m between the front or rear face of a building and any other face of another building
 - b. 3.0 m between the side face of a building and any other side face of another building
6. **Setbacks from a Public Road Right of Way (minimum):**
 - a. 4.0 m for buildings that are 10.0 m or less in height
 - b. 6.0 m for buildings that are more than 10.0 m in height
7. **Setback from a Private Road (minimum):**
 - a. 4.0 m
 - b. 6.0 m where a parking stall is located between the private road and the building
8. **Setbacks from a Lot Line (minimum):**
 - a. 4.0 m for buildings that are 10.0 m or less in height
 - b. 6.0 m for buildings that are more than 10.0 m in height
9. **Building Height (maximum):**
 - a. 12.0 m
10. **Bare Land Condominium Comprehensively Planned Sites**
 - a. Where a comprehensively planned site is developed as a bare land condominium with each condominium unit containing a single dwelling, regulations in Sections 2.7.6.12-2.7.6.13. must be met
 - b. Where a conflict exists between regulations in Sections 2.7.6.5.-2.7.6.9. and regulations in Sections 2.7.6.12.-2.7.6.13, regulations in Sections 2.7.6.12.-2.7.6.13. prevail
11. **Front and Flankage Yard Condominium Unit Boundary Setbacks (minimum):**
 - a. 4.0 m to the principal building from a Front Yard condominium unit boundary
 - b. 3.0 m to the principal building from a Flankage Yard condominium unit boundary
 - c. 6.0 m to an attached garage from a Front Yard condominium unit boundary
12. **Rear Yard Condominium Unit Boundary Setbacks (minimum):**
 - a. 7.5 m to the principal building
 - b. 6.0 m to an attached garage
13. **Side Yard Condominium Unit Boundary Setbacks (minimum):**
 - a. 1.2 m

Option B: Mixed Form Subdivision with Individual Lots

This Option allows for individually owned Lots that front onto a public road. It creates typical subdivisions that contain a diversity of dwelling forms on each block and require more careful planning at the subdivision level than similar subdivisions.

2.7.7. Pre-Development Requirements for a Mixed Form Subdivision with Individual Lots

1. Block Plan

- a. No Development will be allowed in this district unless a block plan is approved by the Development Authority
- b. A block plan must:
 - i. be applied to a contiguous area of at least 0.40 ha
 - ii. assign each proposed residential Lot a dwelling type of either Detached Dwelling, Semi-Detached Dwelling or Row House Dwelling
 - iii. include Lots for Detached Dwelling, Semi-Detached Dwelling or Row House Dwellings
 - iv. indicate the total number of proposed residential Lots and the percentage of each dwelling type
- c. The dwelling type assigned to each proposed residential Lot may be revised if such a change allows the plan to continue to meet all of the regulations required within this section and a revised plan is approved by the Development Authority

2. Diversity of Dwelling Types:

- a. No dwelling type may be less than 10% of the total residential Lots in a plan
- b. No dwelling type may be more than 60% of the total residential Lots in a plan
- c. No more than 6 Lots may be assigned consecutively with the same dwelling type on the same side of the road

2.7.8. Subdivision Regulations for a Mixed Form Subdivision with Individual Lots

1. Block Plan

- a. Must conform to an approved block plan

2. Site Density

- a. The net residential density must be between 25 to 60 Lots per ha

3. Lot Access for Internal Row House Dwelling Units:

- a. Internal Row House Dwelling units must have direct access available to their Rear Yards from public land such as a municipal reserve, environmental reserve, public utility lot, lane or other road right of way, or indirectly via an access easement or other mechanism that will ensure perpetual access is available to their Rear Yards from public land

4. Lot Density (maximum):

- a. 1 Dwelling Unit per Lot

5. Lot Width (minimum):

- a. Detached Dwelling – 7.2 m
- b. Semi-Detached Dwelling – 6.0 m
- c. Row House Dwelling internal unit – 4.3 m
- d. Row House Dwelling end unit – 5.5 m
- e. Corner Lot requires 1.5 m of additional Lot Width

6. Lot Area (minimum):

- a. Detached Dwelling – 180 m²
- b. Semi-Detached Dwelling – 150 m²
- c. Row House Dwelling internal unit – 110 m²
- d. Row House Dwelling end unit – 140 m²
- e. Corner Lot requires 35 m² of additional Lot Area

2.7.9. Development Regulations for a Mixed Form Subdivision with Individual Lots

- 1. Block Plan**
 - a. Must conform to an approved block plan
- 2. Lot Coverage (maximum):**
 - a. 60% for an internal unit Row House Dwelling
 - b. 50% for any other dwelling
- 3. Front and Flankage Yard Setbacks (minimum):**
 - a. 4.0 m to the principal building from the Front Lot Line if the Lot does not have lane access
 - b. 3.0 m to the principal building from the Front Lot Line if the Lot has lane access
 - c. 2.4 m to the principal building from a Flankage Lot Line
 - d. 6.0 m to an attached garage from a Front Lot Line or Flankage Lot Line
- 4. Rear Yard Setbacks (minimum):**
 - a. 7.5 m to the principal building
 - b. 6.0 m to an attached garage
- 5. Side Yard Setbacks (minimum):**
 - a. 1.2 m
- 6. Building Height (maximum):**
 - a. 12.0 m

2.8.0. R7 – Multi-Unit Building Residential District

2.8.1. Purpose

This district provides for medium density housing primarily for infill or redevelopment areas where each multi-unit building is contained within its own Lot.

2.8.2. Permitted Uses

Earthworks
General Accessory Development
Multi-Unit Dwelling
Park
Residential Sale Centre
Row House Dwelling
Supportive Living Facility

2.8.3. Discretionary Uses

Long Term Care Facility
Religious Assembly

2.8.4. Subdivision Regulations

1. **Density (maximum):**
 - a. 80 Dwelling Units per ha
2. **Density (minimum):**
 - a. 30 Dwelling Units per ha
3. **Lot Access for Internal Row House Units**
 - a. Internal Row House Dwelling units must have direct access available to their Rear Yards from public land such as a municipal reserve, environmental reserve, public utility lot, lane or other road right of way, or indirectly via an access easement or other mechanism that will ensure perpetual access is available to their Rear Yards from public land
4. **Lot Area (minimum):**
 - a. 450 m²

2.8.5. Development Regulations

1. **Principal Building**
 - a. The maximum number of principal buildings per Lot is 1
 - b. A principal building must be located solely within a Lot
 - c. All Dwelling Units within a Lot must be contained within a principal building
2. **Density (maximum):**
 - a. 80 Dwelling Units per ha
3. **Density (minimum):**
 - a. 30 Dwelling Units per ha

Figure 2.8.5. – Area of Maximum Dwelling Unit Restriction

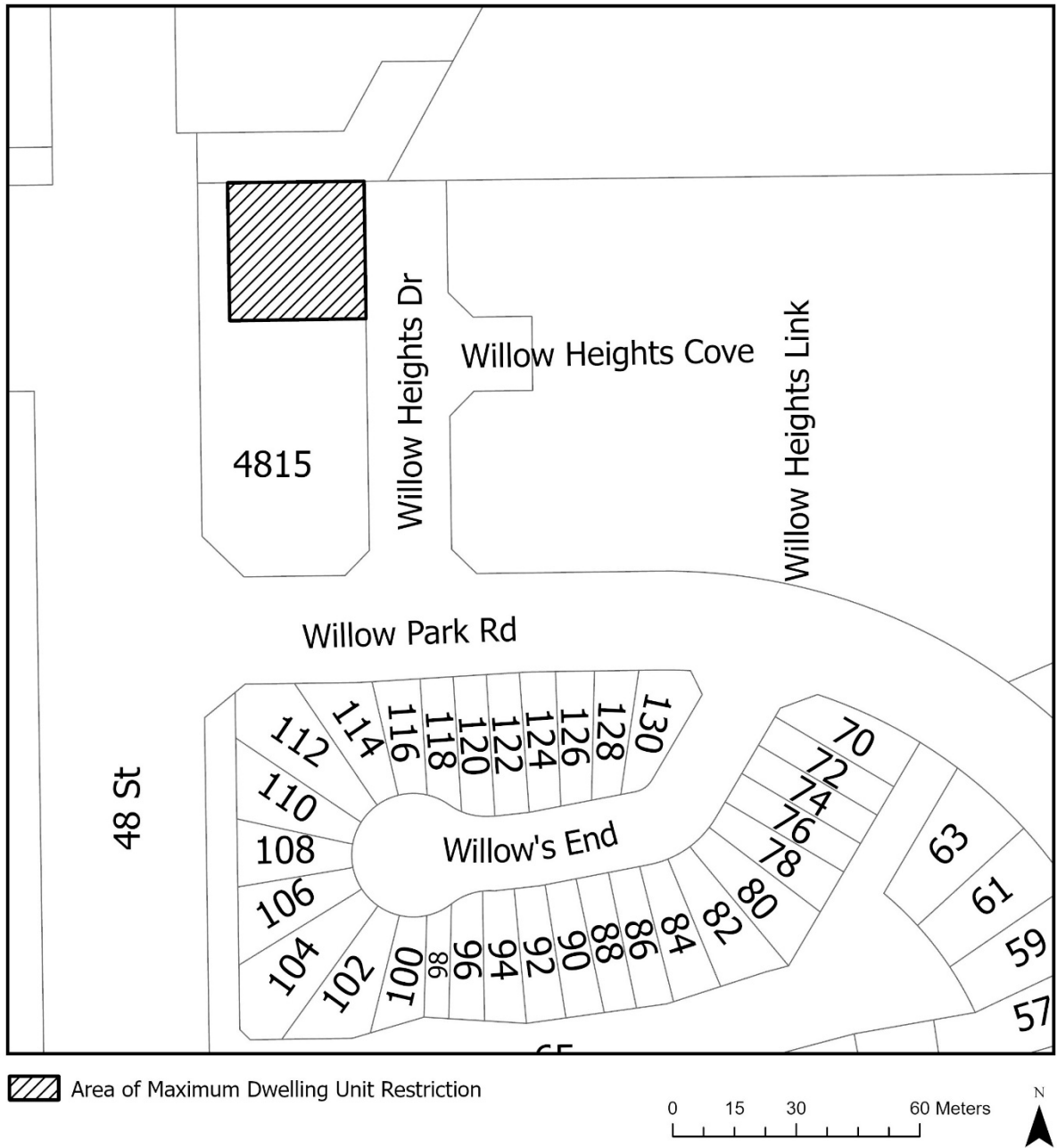

4. Lot Access for Internal Row House Units

- a. Internal Row House Dwelling units must have direct access available to their Rear Yards from public land such as a municipal reserve, environmental reserve, public utility lot, lane or other road right of way, or indirectly via an access easement or other mechanism that will ensure perpetual access is available to their Rear Yards from public land

5. Lot Coverage (maximum):

- a. 50%

6. **Front and Flankage Yard Setbacks (minimum):**
 - a. 4.0 m to the principal building from the Front Lot Line if the Lot does not have lane access
 - b. 3.0 m to the principal building from the Front Lot Line if the Lot has lane access
 - c. 3.0 m to the principal building from a Flankage Lot Line
 - d. 6.0 m to an attached garage from a Front Lot Line or Flankage Lot Line
7. **Rear Yard Setbacks (minimum)**
 - a. 6.0 m to the principal building
 - b. 6.0 m to an attached garage
8. **Side Yard Setbacks (minimum):**
 - a. 1.5 m to the principal building
9. **Building Height (maximum):**
 - a. 12.0 m

2.9.0. R8 – High Density Residential District

2.9.1. Purpose

This district provides medium to high density housing along major roads and redevelopment areas and may include commercial Development.

2.9.2. Permitted Uses

Accessory Dwelling
Earthworks
General Accessory Development
Multi-Unit Dwelling
Park
Residential Sale Centre
Row House Dwelling
Supportive Living Facility

2.9.3. Discretionary Uses

Child Care Service
Detached Dwelling
Duplex Dwelling
Food and Drink Service
Indoor Entertainment Establishment
Indoor Sales and Service
Live Work Unit
Long Term Care Facility
Recreation Facility
Religious Assembly
Residential Vehicle Storage
Semi-Detached Dwelling

2.9.4. Subdivision Regulations

1. **Density (maximum):**
 - a. 80 Dwelling Units per ha and 1 additional Dwelling Unit per ha for every 2 parking stalls provided underground
 - b. No Development may exceed 200 Dwelling Units per ha
2. **Density (minimum):**
 - a. 40 Dwelling Units per ha
3. **Lot Access for Internal Row House Units:**
 - a. Internal Row House Dwelling units must have direct access available to their Rear Yards from public land such as a municipal reserve, environmental reserve, public utility lot, lane or other road right of way, or indirectly via an access easement or other mechanism that will ensure perpetual access is available to their Rear Yards from public land
4. **Lot Area (minimum):**
 - a. 500 m²

2.9.5. Development Regulations

1. **Density (maximum):**
 - a. 80 Dwelling Units per ha and 1 additional Dwelling Unit per ha for every 2 parking stalls provided underground
 - b. No Development may exceed 200 Dwelling Units per ha
2. **Density (minimum):**
 - c. 40 Dwelling Units per ha
3. **Lot Coverage (maximum):**
 - a. 50%
4. **Separation between Buildings within a Development (minimum):**
 - a. 2.4 m between the side face of a building and any other side face of another building where both buildings are less than 12.0 m in height
 - b. 8.0 m between the front or rear face of a building and any other face of another building where none of the buildings are more than 12.0 m in height
 - c. 8.0 m between buildings where at least one building is 12.0 m or more in height
5. **Front and Flankage Yard Setbacks (minimum):**
 - a. 6.0 m to the front or rear face of a building
 - b. 3.0 m to the side face of a building
6. **Rear Yard Setbacks (minimum):**
 - a. 7.5 m to a building
7. **Side Yard Setbacks (minimum):**
 - a. 1.5 m to a building 10.0 m in height or less
 - b. 2.0 m to a building more than 10.0 m in height
 - c. 1.0 m for each additional 5.0 m above 10.0 m in height
8. **Building Height (maximum):**
 - a. 25.0 m, except for Plan 1822573, Block 1, Lot 1, Lot 2, which is limited to 11.5 m in height, as shown in Figure 2.9.5.

Figure 2.9.5. – Area of 11.5 m Height Limitation

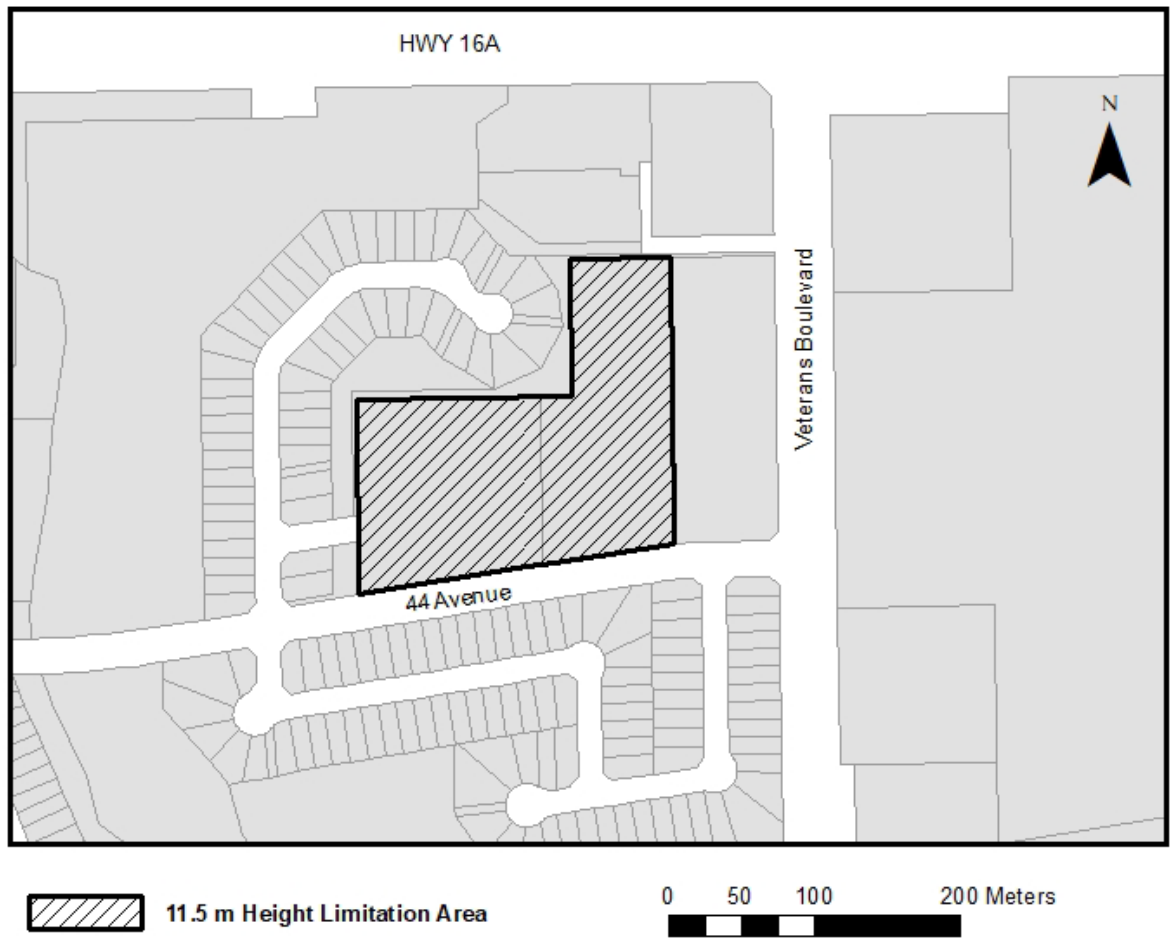

9. **Discretionary Commercial Use Regulations within a Multi-Unit Residential Building with two or more Floors**
 - a. Commercial uses may be allowed to be located where the Site fronts or flanks onto a road right of way
 - b. Commercial uses must be completely contained within the building and must be located below residential uses
 - c. Commercial uses must have an outside entry and internal hallways separate from that of the residential component of the building

2.10.0. C1 – Local Commercial District

2.10.1. Purpose

This district provides Sites for the Development of convenience retail and service outlets that primarily serve Adjacent residential communities and may include residential Development.

2.10.2. Permitted Uses

Car Wash
Community Facility
Child Care Service
Earthworks
Education Service
Food and Drink Service
Gas Bar
General Accessory Development
Government Service
Indoor Entertainment Establishment
Indoor Sales and Service
Park
Private Club
Recreation Facility
Residential Sale Centre

2.10.3. Discretionary Uses

Bar
Cannabis Retail Sales
Live Work Unit
Multi-Unit Dwelling
Outdoor Entertainment Establishment
Religious Assembly
Supportive Living Facility
Tourist Information Centre

2.10.4. Subdivision Regulations

1. **Site Area (minimum):**
 - a. 475 m²
2. **Site Area (maximum):**
 - a. 1.5 ha

2.10.5. Development Regulations

1. **Lot Coverage (maximum):**
 - a. 60%
2. **Floor Area (maximum):**
 - a. 500 m² for any individual business that is not Food and Drink Service or a Child Care Service
 - b. 750 m² for any individual business that is Food and Drink Service or a Child Care Service

3. **Front and Flankage Yard Setbacks (minimum):**
 - a. 6.0 m to the building from the Front Lot Line, or the minimum required Setback of any district for properties immediately Abutting the Site along the same frontage
 - b. 4.0 m to the building from the Flankage Lot Line
4. **Rear Yard Setbacks (minimum):**
 - a. 7.0 m where a Rear Yard is used to provide vehicular access to the rear of the Lot
 - b. 6.0 m for all other Rear Yards
5. **Side Yard Setbacks (minimum):**
 - a. 7.0 m where a Side Yard is used to provide vehicular access to the rear of the Lot
 - b. 3.0 m for a Side Yard Adjacent to a residential district
 - c. 2.0 m for all other Side Yards
6. **Building Height (maximum):**
 - a. 14.0 m
7. **Number of Car Wash Bays (maximum):**
 - a. 2
8. **Multi-Unit Dwelling Uses**
 - a. Multi-Unit Dwelling Uses are only allowed above a non-residential use

2.11.0. C2 – General Commercial District

2.11.1. Purpose

This district provides for a broad range of businesses and may include residential Development. This district is predominately located along collector and arterial roads, and highways to provide easy access and visibility.

2.11.2. Permitted Uses

Bar
Car Wash
Child Care Service
Community Facility
Contractor Service
Earthworks
Education Service
Food and Drink Service
Funeral Home
Gas Bar
General Accessory Development
Government Service
Hotel
Indoor Entertainment Establishment
Indoor Sales and Service
Motel
Outdoor Entertainment Establishment
Park
Private Club
Recreation Facility
Residential Sale Centre
Theatre
Tourist Information Centre

2.11.3. Discretionary Uses

Automotive and Recreation Vehicle Sales and Service
Campground
Cannabis Retail Sales
Heavy Vehicle and Equipment Sale and Service (see Section 2.11.5.9.)
Microbrewery
Mini Storage (see Section 2.11.5.9.)
Multi-Unit Dwelling
Outdoor Display Area Accessory Development
Outdoor Sales and Service
Outdoor Storage Accessory Development
Parking Facility
Recycling Depot
Religious Assembly
Shipping Container Accessory Development
Supportive Living Facility

2.11.4. Subdivision Regulations

1. **Site Area (minimum):**
 - a. 0.20 ha
2. **Municipal Servicing Requirement**
 - a. Full municipal servicing will be required by the Subdivision Authority prior to the endorsement of a plan of subdivision

2.11.5. Development Regulations

1. **Lot Coverage (maximum):**
 - a. 60%
2. **Setback from Highway 16A:**
 - a. No building may be erected within 15.0 m of the Highway 16A right of way
3. **Front and Flankage Yard Setbacks (minimum):**
 - a. 6.0 m
4. **Rear Yard Setbacks (minimum):**
 - a. 7.0 m where a Rear Yard is used to provide vehicular access to the rear of the property
 - b. 6.0 m for all other instances
5. **Side Yard Setbacks (minimum):**
 - a. 7.0 m where a Side Yard is used to provide vehicular access to the rear of the property
 - b. 4.0 m for all other instances
6. **Building Height (maximum):**
 - a. 20.0 m
7. **Access**
 - a. Site access will be determined by the Development Authority, which will be done in consultation with Alberta Transportation and Economic Corridors for any Site located Adjacent to or nearby a highway
8. **Contractor Service Use**
 - a. Contractor Service is only allowed within an enclosed building
9. **Limited Commercial General Uses**
 - a. Development permits for Heavy Vehicle and Equipment Sale and Service and Mini Storage uses in the C2 – General Commercial District will only be approved where these uses are present at the adoption of this Bylaw.
 - b. The following Lots are used for Mini Storage at the adoption of this Bylaw, as shown in Figure 2.11.5.:
 - i. Plan 8193ET Parcel A, comprising both Lots
 - c. The following Lots are used for Heavy Vehicle and Equipment Sale and Service at the adoption of this Bylaw, as shown in Figure 2.11.5.:
 - i. Plan 154HW Parcel A
 - ii. Plan 9023388; RLY; 52
 - iii. Plan 7820441 Block 1 Lot 8

Figure 2.11.5. – Lots allowed for Heavy Vehicle and Equipment Sale and Service and Mini Storage Uses

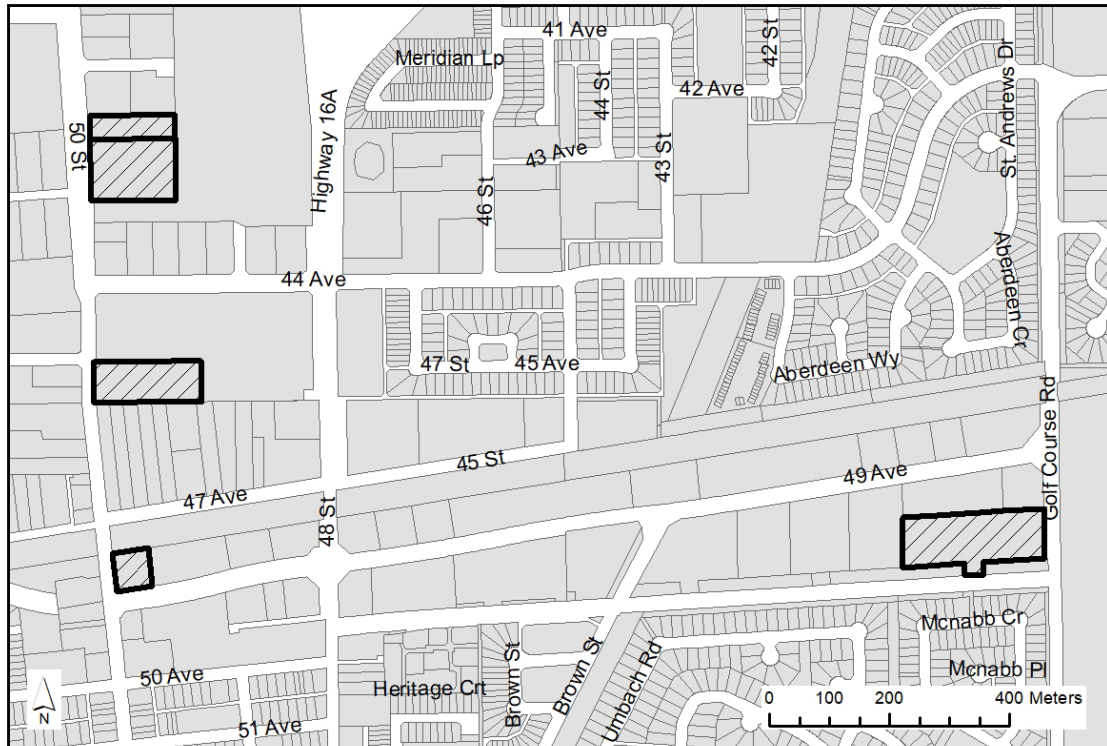

 Lots allowed for Heavy Vehicle and Equipment Sales or Mini Storage Uses

10. Multi-Unit Dwelling Uses

- a. Multi-Unit Dwelling Uses in a new development:
 - i. are only allowed above a non-residential use which is identified as a Permitted Use or a Discretionary Use in both the C2 - General Commercial District, in Sections 2.11.2. or 2.11.3., and the C3 - Central Mixed Use District, in Sections 2.12.2. or 2.12.3.;
 - ii. must not front onto roads with a speed limit greater than 60 km/h without a suitable buffer;
 - iii. must be within 200 m of a residential district or C3 – Central Mixed Use District;
 - iv. must be connected to municipal servicing; and
 - v. must have direct access to and connect with the pedestrian walkway system of the Municipality.
- b. Where there is a change of use proposed within an existing development that contains a Multi-Unit Dwelling use above a non-residential use, only a non-residential use identified as a Permitted Use in the C2 - General Commercial District, in Section 2.11.2., and as a Permitted Use or a Discretionary Use in the C3 - Central Mixed Use District, in Sections 2.12.2. or 2.12.3., is allowed.

2.12.0. C3 – Central Mixed Use District

2.12.1. Purpose

This district provides for a pedestrian-oriented residential, service and retail environment in the historic heart of the community.

2.12.2. Permitted Uses

Accessory Dwelling
Bed and Breakfast
Community Facility
Child Care Service
Duplex Dwelling
Earthworks
Education Service
Food and Drink Service
General Accessory Development
Government Service
Indoor Entertainment Establishment
Indoor Sales and Service
Live Work Unit
Multi-Unit Dwelling
Park
Private Club
Recreation Facility
Row House Dwelling
Semi-Detached Dwelling
Supportive Living Facility

2.12.3. Discretionary Uses

Bar
Cannabis Retail Sales
Car Wash
Detached Dwelling
Funeral Home
Gas Bar
Hospital
Hotel
Long Term Care Facility
Major Home Occupation
Microbrewery
Outdoor Display Area Accessory Development
Outdoor Entertainment Establishment
Outdoor Storage Accessory Development
Parking Facility
Religious Assembly
Residential Sale Centre
Shipping Container Accessory Development
Theatre
Tourist Information Centre

2.12.4. Subdivision Regulations

- 1. Lot Access for Internal Row House Dwelling Units**
 - a. Internal Row House Dwelling units must have direct access available to their Rear Yards from public land such as a municipal reserve, environmental reserve, public utility lot, lane or other road right of way, or indirectly via an access easement or other mechanism that will ensure perpetual access is available to their Rear Yards from public land
- 2. Lot Width along a Road Right of Way (minimum):**
 - a. 3.0 m where there is rear lane access
 - b. 4.5 m where there is no rear lane access
- 3. Lot Area (minimum):**
 - a. 140 m²

2.12.5. Development Regulations

- 1. Density (minimum):**
 - a. 35 Dwelling Units per ha, except where there is 1 Dwelling Unit is planned per Lot then no minimum is required
- 2. Lot Access for Internal Row House Dwelling Units**
 - a. Internal Row House Dwelling units must have direct access available to their Rear Yards from public land such as a municipal reserve, environmental reserve, public utility lot, lane or other road right of way, or indirectly via an access easement or other mechanism that will ensure perpetual access is available to their Rear Yards from public land
- 3. Lot Coverage (maximum):**
 - a. 100% for any Lot between the railway tracks and the lane between 53 Avenue and 54 Avenue that has frontage onto 50 Street, as shown in Figure 2.12.5.
 - b. 60% for all other Lots

Figure 2.12.5. – Lots required to have a Non-Residential Use on the First Level Above Grade



 Lots required to have a non-residential use

4. **Front and Flankage Yard Setbacks (minimum):**
 - a. 0.0 m for any Lot between the railway tracks and the lane between 53 Avenue and 54 Avenue that has frontage onto 50 Street, as shown in Figure 2.12.5.
 - b. for all other Lots:
 - i. 3.0 m for a residential use
 - ii. 0.0 m for a non-residential use
 - iii. 6.0 m to an attached garage from a Front Lot Line or Flankage Lot Line
5. **Rear Yard Setbacks (minimum):**
 - a. 0.0 m for any Lot between the railway tracks and the lane between 53 Avenue and 54 Avenue that has frontage onto 50 Street, as shown in Figure 2.12.5.
 - b. 6.0 m for all other Lots
6. **Side Yard Setbacks (minimum):**
 - a. 0.0 m for any Lot between the railway tracks and the lane between 53 Avenue and 54 Avenue that has frontage onto 50 Street, as shown in Figure 2.12.5.
 - b. for all other Lots:
 - i. 1.5 m to a building 10.0 m in height or less
 - ii. 2.0 m to a building more than 10.0 m in height, plus an additional 1.0 m for each additional 5.0 m above 10.0 m in height
7. **Building Height (maximum):**
 - a. 25.0 m

8. **Comprehensively Planned Sites:**
 - a. Any comprehensively planned site must meet the regulations in Section 2.7.6, and where a conflict exists between regulations in Section 2.7.6 and regulations in Section 2.12.5., regulations in Section 2.12.5. prevail
9. **Development along 50 Street**
 - a. Any Development on a Lot between the railway tracks and the lane between 53 Avenue and 54 Avenue that has frontage onto 50 Street must contain a non-residential use on the first level above grade along 50 Street, as shown in Figure 2.12.5.

2.12.6. Development Standards

1. Where any Development south of the centre line of 50 Avenue is non-residential on the first level above grade, as shown in Figure 2.12.6.:
 - a. no lands between the Facade of the building and the Front Lot Line are allowed to be used for parking, storage or as a garage, except north of 50 Avenue, and
 - b. a principal entry is required in the front Facade of the building
2. Driveways and parking for a new Development are restricted to the rear of a property where there is lane access
3. Developments are not permitted to have drive-through operations

Figure 2.12.6. – Lots with Development Restrictions for Non-Residential Uses on the First Level Above Grade



2.13.0. M1 – Business Industrial District

2.13.1. Purpose

This district provides for commercial, and light and medium industrial uses.

2.13.2. Permitted Uses

Automotive and Recreation Vehicle Sales and Service
Car Wash
Contractor Service
Earthworks
Gas Bar
General Accessory Development
Government Service
Heavy Vehicle and Equipment Sale and Service
Heavy Vehicle and Equipment Wash Facility
Indoor Entertainment Establishment
Indoor Farm
Indoor Sales and Service
Light Industrial
Microbrewery
Mini Storage
Outdoor Display Area Accessory Development
Outdoor Sales and Service
Outdoor Storage Accessory Development
Park
Prefabricated Structure Accessory Development
Recycling Depot
Shipping Container Accessory Development
Warehousing

2.13.3. Discretionary Uses

Adult Entertainment
Auctioneering
Campground
Cannabis Production and Distribution Facility
Cannabis Retail Sales
Distillery
Education Service
Hotel
Food and Drink Service
Kennel
Medium Industrial
Motel
Outdoor Entertainment Establishment
Private Club
Recreation Facility
Religious Assembly
Snow Dump Site
Surveillance Suite Accessory Development

Tourist Information Centre
Veterinary Hospital

2.13.4. Subdivision Regulations

1. **Site Area (minimum):**
 - a. 0.20 ha for Sites with full municipal servicing
 - b. 0.80 ha for Sites without full municipal servicing
2. **Municipal Servicing Requirement**
 - a. Full municipal servicing will be required by the Subdivision Authority prior to the endorsement of a plan of subdivision

2.13.5. Development Regulations

1. **Lot Coverage (maximum):**
 - a. 60%
2. **Front and Flankage Yard Setbacks (minimum):**
 - a. 6.0 m from the building to the Front Lot Line or Flankage Lot Line, except where a greater distance is deemed necessary by the Development Authority
3. **Rear Yard Setbacks (minimum):**
 - a. 7.0 m where a Rear Yard is used to provide vehicular access to the rear of the property
 - b. 6.0 m where a Rear Yard Abuts a residential district
 - c. 3.0 m in all other instances
4. **Side Yard Setbacks (minimum):**
 - a. 7.0 m where a Side Yard is used to provide vehicular access to the rear of the property
 - b. 6.0 m where a Side Yard Abuts a residential district
 - c. 2.0 m in all other instances
5. **Building Height (maximum):**
 - a. 20.0 m
6. **Landscaping**
 - a. 2.0 m of landscaping along road rights of way must be provided if there is no landscaping within Adjacent road right of way boulevards

2.14.0. P1 – Parks District

2.14.1. Purpose

This district provides land for the Development of parks to meet the active and passive recreational pursuits of the public.

2.14.2. Permitted Uses

Campground
Cemetery
Community Garden
Earthworks
General Accessory Development
Park
Recreation Facility

2.14.3. Discretionary Uses

Bar
Community Facility
Education Service
Food and Drink Service
Indoor Entertainment Establishment
Indoor Sales and Service
Outdoor Entertainment Establishment
Parking Facility
Prefabricated Structure Accessory Development
Religious Assembly
Shipping Container Accessory Development
Tourist Information Centre

2.14.4. Development Regulations

1. **Front, Rear, Side and Flankage Yard Setbacks (minimum):**
 - a. 4.0 m
 - b. 6.0 m where a Yard Abuts a residential district
2. **Building Height (maximum):**
 - a. 20.0 m
3. **Landscaping:**
 - a. 2.0 m of landscaping along road rights of way must be provided if there is no landscaping within Adjacent road right of way boulevards
4. **Discretionary Commercial Uses:**
 - a. Bar, Food and Drink Service, Indoor Entertainment Establishment and Indoor Sales and Service will only be allowed in association with a Permitted Use

2.15.0. P2 – Community Services District

2.15.1. Purpose

This district provides for the Development of publicly or privately owned community services.

2.15.2. Permitted Uses

Community Facility
Community Garden
Child Care Service
Earthworks
Education Service
General Accessory Development
Government Service
Hospital
Outdoor Storage Accessory Development
Park
Recreation Facility
Religious Assembly

2.15.3. Discretionary Uses

Bar
Cemetery
Food and Drink Service
Indoor Entertainment Establishment
Indoor Sales and Service
Outdoor Entertainment Establishment
Parking Facility
Prefabricated Structure Accessory Development
Private Club
Shipping Container Accessory Development
Surveillance Suite Accessory Development
Theatre
Tourist Information Centre

2.15.4. Development Regulations

1. **Lot Coverage (maximum):**
 - a. 70%
2. **Front, Rear, Side and Flankage Yard Setbacks (minimum):**
 - a. 4.0 m
 - b. 6.0 m where a Yard Abuts a residential district
3. **Building Height (maximum):**
 - c. 20.0 m
4. **Landscaping**
 - d. 2.0 m of landscaping along road rights of way must be provided if there is no landscaping within Adjacent road right of way boulevards

5. **Discretionary Commercial Uses:**

- a. Bar, Food and Drink Service, Indoor Entertainment Establishment, Indoor Sales and Service, Outdoor Entertainment Establishment and Theatre uses will only be allowed in association with a Permitted Use

2.16.0. P3 – Utility District

2.16.1. Purpose

This district provides land for major utilities.

2.16.2. Permitted Uses

Earthworks
General Accessory Development
Government Service
Park

2.16.3. Discretionary Uses

Energy Generating Facility
Outdoor Storage Accessory Development
Parking Facility
Prefabricated Structure Accessory Development
Recreation Facility
Recycling Depot
Shipping Container Accessory Development
Snow Dump Site
Transfer Station

2.16.4. Development Regulations

1. **Lot Coverage (maximum):**
 - a. 70%
2. **Landscaping**
 - a. 2.0 m of landscaping along road rights of way must be provided if there is no landscaping within Adjacent road right of way boulevards
3. **Building Height (maximum):**
 - a. 20.0 m
4. **Front, Rear, Side and Flankage Yard Setbacks (minimum):**
 - a. 6.0 m

2.17.0. FD – Future Development District

2.17.1. Purpose

This district reserves those areas within the municipality which are rural in character until such time that the land is required for urban purposes. Development must be consistent with the future development concepts within the Municipal Development Plan. The redistricting of land to other land use districts will normally occur subsequent to the approval of an area structure plan and prior to the endorsement of a proposed subdivision.

2.17.2. Permitted Uses

Accessory Dwelling
Community Garden
Earthworks
General Accessory Development
Indoor Farm
Park
Rural Farm

2.17.3. Discretionary Uses

Auctioneering
Bed and Breakfast
Campground
Cannabis Production and Distribution Facility
Cemetery
Contractor Service
Detached Dwelling
Kennel
Major Home Occupation
Medium Industrial
Outdoor Display Area Accessory Development
Outdoor Sales and Service
Outdoor Storage Accessory Development
Prefabricated Structure Accessory Development
Recreational Vehicle Storage Facility
Religious Assembly
Shipping Container Accessory Development
Veterinary Hospital

2.17.4. Subdivision Regulations

1. **Density (maximum):**
 - a. 1 Dwelling Unit per Lot
 - b. 1 Accessory Dwelling per Lot may be allowed where the Accessory Dwelling will not prejudice the possibility of future Development of the area
2. **Site Area (minimum):**
 - a. 8.0 ha
3. **Area Structure Plan Requirement**
 - a. Preparation and adoption of an area structure plan will be required by the Subdivision Authority prior to consideration of an application for redistricting or subdivision

- b. Adoption of an area structure plan is not required when the first, and a single lot, is being subdivided out of a quarter section.

2.17.5. Development Regulations

1. **Front, Rear, Side and Flankage Yard Setbacks (minimum):**
 - a. 6.0 m
2. **Building Height (maximum):**
 - a. 12.0 m, except in the case of buildings or structures accessory to a farm operation
3. **Rural Farm Uses**
 - a. Rural Farm uses must not include any intensive agricultural Developments, such as the breeding and raising of fur bearing animals, poultry, hogs or feedlot operations
 - b. Structures related to Rural Farm uses involving livestock will not be allowed within 100 m of a residential or commercial district
4. **Future Development Considerations**
 - a. The Development Authority may specify the length of time a use is allowed in this district having regard for the servicing and future urban development of the subject land
5. **Limited Future Development Uses**
 - a. Development permits for Auctioneering, Campground, Cannabis Production and Distribution Facility, Cemetery, Contractor Service, Kennel, Outdoor Sales and Service, Outdoor Storage Accessory Development, Prefabricated Structure Accessory Development, Recreational Vehicle Storage Facility, Shipping Container Accessory Development and Veterinary Hospital uses in the FD – Future Development district will only be approved where these uses are not within a residential subdivision or on a Lot where a residential use is the Principal Use
6. **Limited and Temporary Medium Industrial Uses**
 - a. A development permit may only be issued for Medium Industrial uses within NW $\frac{1}{4}$ Section 6-53-27-W4, as shown in Figure 2.17.5.
 - b. A development permit under Section 2.17.5.6.a. may only be issued and valid:
 - i. until December 31, 2026, unless an area structure plan is approved for the subject area that supports a Medium Industrial use; and
 - ii. when the use does not require servicing.

Figure 2.17.5. – Area Allowed for Medium Industrial Uses



 Area Allowed for Medium Industrial Uses

PART 3 - GENERAL REGULATIONS

Site Development

3.1.0. Communal Amenity Space

3.1.1. Communal Amenity Space Regulations

1. A Development that contains 50 or more Dwelling Units that requires a comprehensive site development and servicing plan, or a Multi-Unit Dwelling containing 50 or more Dwelling Units, is required to provide communal amenity space for passive or active recreational use.
2. Communal amenity space must be indoor or outdoor space, or a combination thereof, including but not limited to Landscaped courtyards, communal gardens, public seating areas, swimming facilities, fitness rooms, party rooms, dining or kitchen areas, games rooms and play areas for children complete with equipment.
3. A minimum communal amenity area of 2.0 m² per dwelling must be provided and be developed as recreational space and be grouped into areas of not less than 50.0 m².

3.2.0. Comprehensive Site Development and Servicing Plan

3.2.1. Comprehensive Site Development and Servicing Plan Regulations

1. Where a Site is composed of multiple Lots or is to be developed in phases, the Development Authority requires the submission of a comprehensive site development and servicing plan for the entire project area.
2. Where a Lot includes more than one building or use, the Development Authority may require the submission of a comprehensive site development and servicing plan for the entire project area.
3. A comprehensive site development and servicing plan must:
 - a. show the location of all existing and proposed Lot Lines, easements or rights of way, buildings, structures, parking and loading areas, drive aisles, roads, lanes, accesses, sidewalks, trails, surface and underground utilities, surface drainage patterns, landscaping, vegetation, and other features reasonably required, such as signage, vehicular directional signs, garbage enclosures and fencing to ensure compliance with the provisions of this Bylaw;
 - b. include dimensions and details of the items listed in Section 3.2.1.3.a. reasonably required to ensure compliance with the provisions of this Bylaw; and
 - c. provide an internal pedestrian circulation system designed to have direct and visible connections to the public pathway system and facilitate safe pedestrian movement throughout the site.

3.3.0. Landscaping

3.3.1. Landscape Plan Required

1. A landscaping plan is required for any development permit application within:
 - a. R6 – Comprehensively Planned Residential District;
 - b. R8 – High Density Residential District;
 - c. C1 – Local Commercial District; and
 - d. C2 – General Commercial District.
2. A landscaping plan may be required for any development permit application within:
 - a. R7 – Multi-Unit Building Residential District;
 - b. C3 – Central Mixed Use District;
 - c. M1 – Business Industrial District;
 - d. P1 – Parks District;
 - e. P2 – Community Services District; and
 - f. P3 – Utility District.
3. Landscaping work may only commence once a landscaping plan is approved by the Development Authority.
4. The Development Authority may require that the applicant provide security for landscaping.
5. Any changes to an approved Landscape plan must be authorized by the Development Authority.

3.3.2. Landscape Plan Content

1. Where a Landscape plan is required, it must include the following:
 - a. boundaries and dimensions of the Site and Adjacent land uses;
 - b. location of Adjacent sidewalks, trails, driveway entrances, lanes, and the location and name of Adjacent roads;
 - c. footprint and dimensions for all buildings or structures;
 - d. location of any utility lines or rights of way;
 - e. location and description or illustrations of all existing or proposed physical features, which may include Fences, flower beds, berm contours, outdoor furniture, decorative paving, water features; and
 - f. location of all existing and proposed plant materials, with a descriptive list identifying the common and botanical name, quantity and size at planting.

3.3.3. General Landscaping Regulations

1. Landscaping must be provided in those areas of the Site, which are not covered by buildings, required parking areas and maneuvering areas, unless otherwise specified in the district in which the Site is located.
2. For residential uses, a minimum of 20% of the Lot must be Landscaped.
3. For residential Lots with less than three dwellings, the Front Yard must be Landscaped to:
 - a. a minimum of 15% for Pie-Shaped Lots; and
 - b. a minimum of 20% for all other types of Lots.
4. For a commercial use, a minimum of 10% of the Lot must be Landscaped, which must include any area within 2.0 m of:
 - a. the front Lot Line; or
 - b. a side Lot Line that Abuts a road right of way or a residential district.
5. For an industrial use, any area within 2.0 m of the following must be Landscaped, except where a 2.0 m wide Landscaped boulevard is provided within the Adjacent road right of way:

- a. the Front Lot Line; or
 - b. a Side Lot Line that Abuts a road right of way or a residential district.
6. In any Landscaped area for a non-residential Lot, trees or shrubs must be planted in the overall minimum ratio of one tree or two shrubs per 75.0 m² of the area to be Landscaped.
 7. In any Landscaped area for a Multi-Unit Dwelling Development and for a residential Lot that requires a comprehensive site development and servicing plan, trees or shrubs must be planted in the overall minimum ratio of one tree or two shrubs per 50.0 m² of the area to be Landscaped.
 8. Plant materials must be:
 - a. deciduous trees – minimum caliper 40 mm;
 - b. coniferous trees – minimum height 1.2 m;
 - c. shrubs – minimum height or spread of 0.50 m; and
 - d. hardy to the Stony Plain region.
 9. Landscaping must be completed within two years of the issuance of a permit, except where a Development Authority determines that based on the complexity or significance of a Development that one additional year may be given to complete the landscaping.
 10. Rooftop landscaping may be used to meet up to 50% of a landscaping coverage requirement of a Site within the C1 – Local Commercial District, C2 – General Commercial District, C3 – Central Mixed Use District, R6 – Comprehensively Planned Residential District and R8 – High Density Residential District when within common areas.

3.4.0. Lighting

3.4.1. Lighting Requirements

1. Where artificial outdoor lighting is provided to illuminate any Lot, building or Site, the type and location of lighting must:
 - a. serve a useful purpose and be limited to what is necessary for the particular use;
 - b. be designed, planned and implemented appropriately;
 - c. avoid undue illumination of the neighbouring parcels;
 - d. not adversely affect the use, enjoyment and privacy of any dwelling and its amenity spaces; and
 - e. not interfere with traffic safety on any road.

3.5.0. Natural Conservation Areas

3.5.1. Natural Conservation Area Requirements

1. A natural conservation area is an area of park space intended to be kept in a state that preserves natural landscaping and drainage patterns, creates and supports habitats and encourages ecological sustainability.
2. Development within a natural conservation area will be limited to educational signage, enhanced stormwater drainage and maintenance, pathways, sitting areas and similar landscaping elements.
3. Development within a natural conservation area will follow principles of dark sky and low impact development.
4. Maintenance within a natural conservation area will focus on naturalization with native vegetation, management of invasive species and safety.
5. The following lands shown in Figure 3.5.1. are considered to be natural conservation areas.

Figure 3.5.1. – Natural Conservation Area

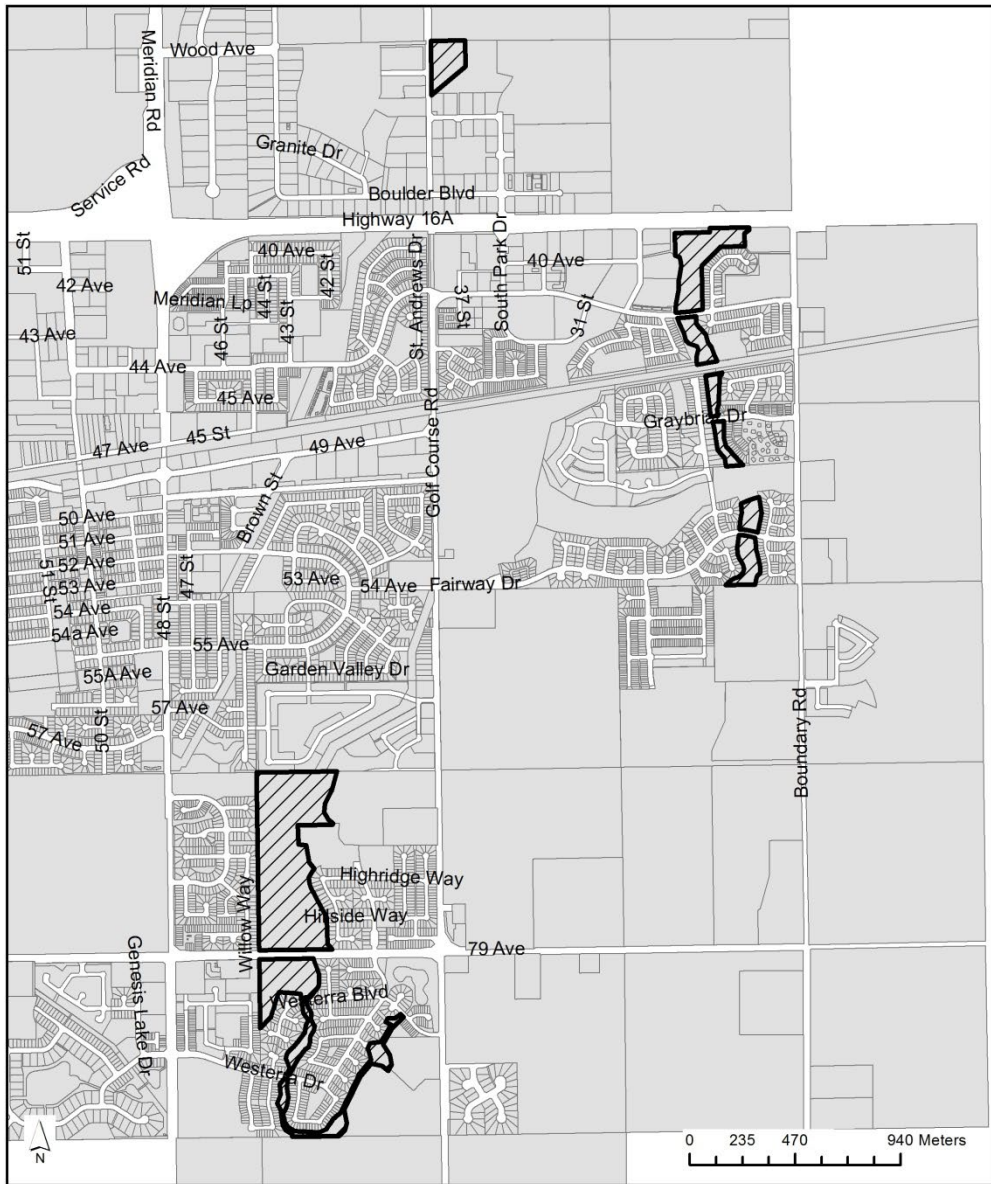

 Natural Conservation Area

3.6.0. Sight Line Control

3.6.1. Sight Line Control Regulations

1. The location of a building on a corner Site is subject to approval by the Development Authority who may take into account:
 - a. the location of existing Adjacent buildings; and
 - b. the required Setback on Adjacent Sites.
2. There will be no planting, structure or other object more than 1.0 m in height in or on that part of a corner Site located within any district other than a commercial building in the C3 – Central Mixed Use District, which lies within any sight triangle as described below and shown in Figure 3.6.1.:
 - a. where two roads intersect, the sight triangle is the area contained between three points, which are located at the point where the curbs of the interacting roads would intersect if extended and each point along each curb of the intersecting roads that is 8.0 m from the first point;
 - b. where a road intersects with a lane, the sight triangle is the area contained between three points, which are located at the point where the curb of the interacting road meets the edge of the Hard Surfaced portion of the lane, the point along the curb of the intersecting road that is 5.0 m from the first point and the point along the edge of the Hard Surfaced portion of the lane that is 5.0 m from the first point; or
 - c. where a lane intersects with a lane, the sight triangle is the area contained between three points, where the Hard Surfaced portion of the interacting lane meets the edge of the Hard Surfaced portion of the other lane, the point along the edge of the intersecting lane that is 3.0 m from the first point, and the point along the edge of the other lane that is 3.0 m from the first point.

Figure 3.6.1. – Sight Line Triangle

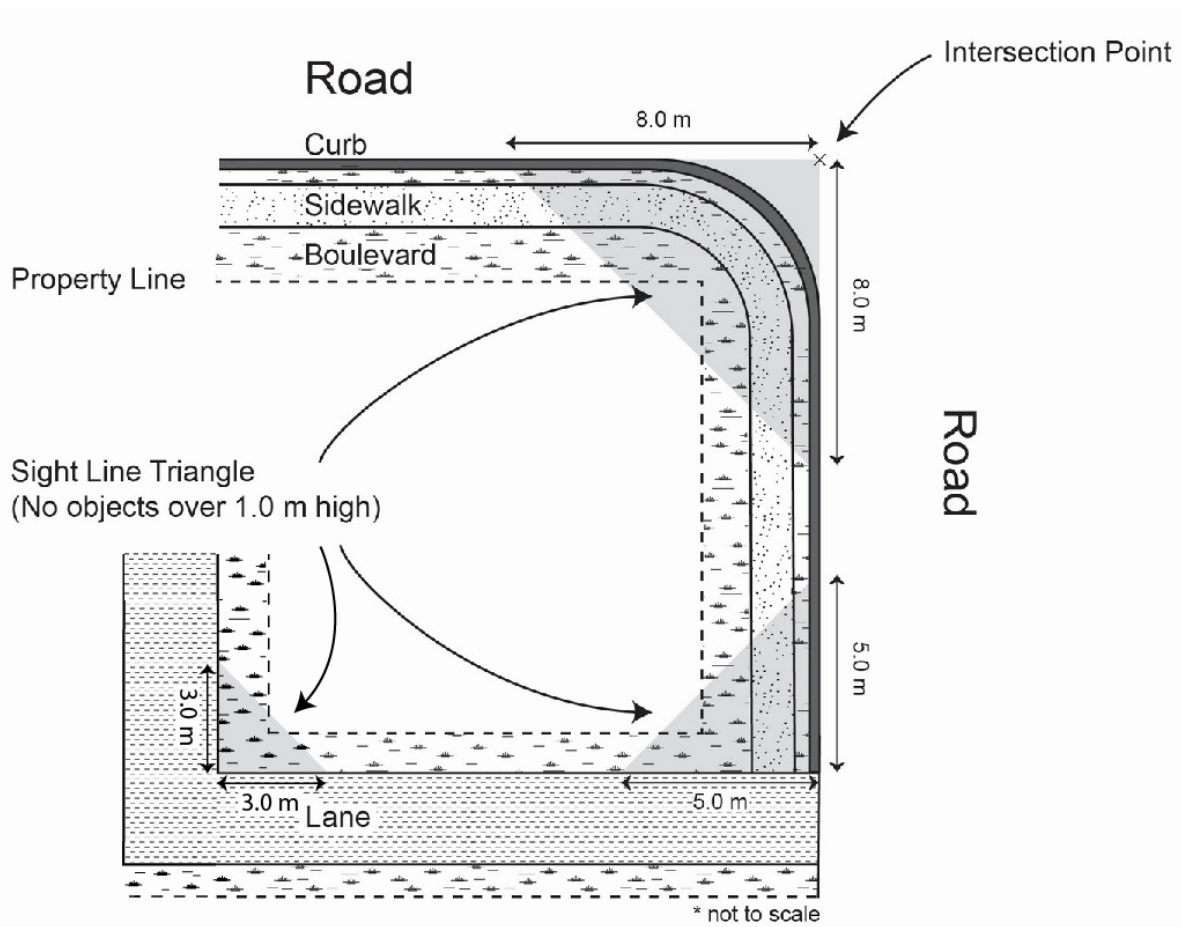

3.7.0. Solid Waste, Recycling and Organic Collection Facilities

3.7.1. Solid Waste, Recycling and Organic Collection Facility Requirements

1. All Developments must provide a facility for the collection of solid waste, recycling and organic material suitable for the intended land use.
2. Solid waste, recycling and organic facilities must be:
 - a. equipped with weatherproof and animal proof containers;
 - b. screened from Adjacent Sites and public thoroughfares; and
 - c. provided in a location easily accessible for pickup.

3.8.0. Yards and Projections into Yards

3.8.1. Determining Yards

1. The Front Yard for an internal Lot is the portion of the Site that Abuts the road.
2. To determine the Front Yard on a Corner Lot, consideration will be given to the orientation of the Lots on the same block face and will be taken on the same road as the Abutting properties.
3. The Front Yard for Lots other than a corner Site, that have frontage onto two roads, will be determined by the Development Authority, consideration will be given to the orientation of other buildings in the area.

Figure 3.8.1. – Yard Types

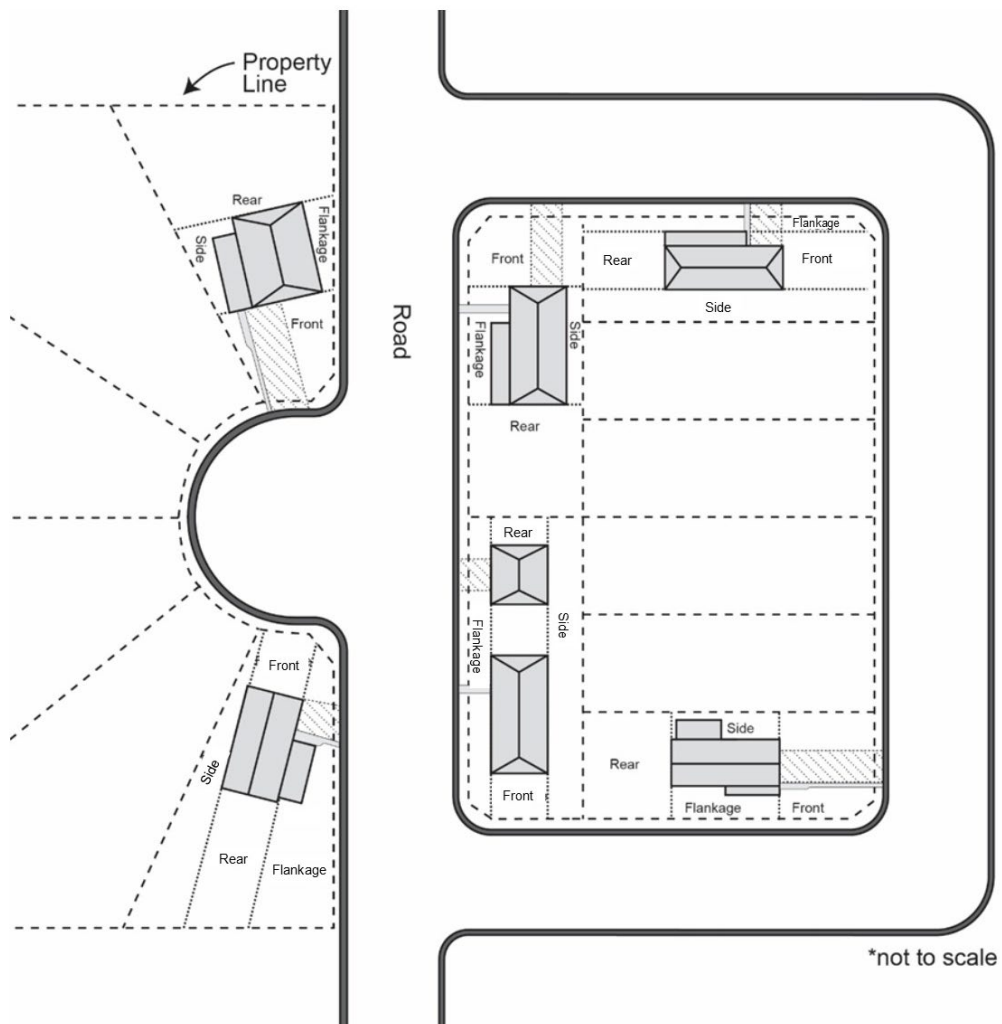

3.8.2. Yard Requirements

1. An improvement, such as a retaining wall, unenclosed patio, sidewalk or set of steps, within a Yard must be contained within the Lot and not cross any Lot Lines except when the improvement provides access from the Site to a road right of way.

3.8.3. Projection allowed into Yards

1. Projections over or into a Yard are not permitted unless they are described in Table 3.8.3.
2. Notwithstanding Section 3.8.3.1., Decks and balconies may not project into any minimum separation distances between buildings.

TABLE 3.8.3. PROJECTIONS ALLOWED INTO YARDS				
Structure	Front Yard	Rear Yard	Side and Flankage Yards	Requirement
Sills, Eaves, Gutters	0.6 m	0.6 m	0.6 m	
Exterior steps, staircases, landings, or wheelchair ramps	Up to the Lot Line	Up to the Lot Line	Up to the Lot Line	These structures in a Yard must not cause obstruction for emergency access to any other Yard.
Chimneys, Chimney chase	0.6 m	0.6 m	0.6 m	These may not include living space features like bookcases, closets or shelving that are part of a cantilever-like projection.
Cantilevers	0.6 m	0.6 m	None	All cantilevers must meet the minimum required Side Yard Setbacks.
Bay windows, Bow windows	0.6 m	0.6 m	None	Bay and bow windows are not allowed in any required Side Yard.
Decks, balconies	None	3.5 m	None	These projections are for the C3, R1, R2, R4, R5, R6, and R7 Districts.
Decks, balconies	2.5 m	2.5 m	None	These projections are for the R8 District.

3.8.4. Yard Setback Exceptions

1. Provided that Lot grading and any necessary emergency access are not impacted, the minimum distances required for Yards do not apply to:
 - a. construction wholly beneath the surface of the ground other than storage tanks; and
 - b. an improvement provided that their floor surface does not rise more than 0.60 m above the finished ground elevation.

Temporary Development

3.9.0. Temporary Development

3.9.1. Temporary Development Regulations

1. An application for a Temporary Development, may be considered by the Development Authority, provided that the use, building, or structure is listed as a Permitted Use or Discretionary Use, in the relevant land use district.
2. A Temporary Development may be approved for a period of up to three years.
3. For a Temporary Development, the Development Authority may require the submission of a site remediation plan and may require a development security deposit which will only be returned once the Temporary Development ceases and the Site has been remediated to the satisfaction of the Development Authority.
4. The Development Authority may exempt Temporary Developments from landscaping, Hard Surfaced parking, and internal roadway requirements, where meeting these requirements would cause undue hardship for the final build-out of the Site.
5. Where a temporary development involves outdoor storage, the development will only be allowed within the M1 – Business Industrial District and a wooden Fence or other product of equal screening value must be constructed to a minimum of 1.8 m and a maximum of 2.4 m in height to screen the outdoor storage.

Proximity to Features

3.10.0. Proximity to a Railway Right of Way

3.10.1. Proximity to a Railway Right of Way Requirements

1. Any residential, Long Term Care Facility, Supportive Living Facility, Hotel, Motel, Education Service, Religious Assembly, Community Facility, Hospital or Child Care Service uses must be a minimum distance of 30.0 m from the boundary of the railway right of way to the nearest wall of the building.
2. All other uses must be a minimum distance of 15.0 m from the boundary of the railway right of way to the nearest wall of the building.

3.11.0. Proximity to a Water Body or a Stream Course

3.11.1. Proximity to a Water Body or a Stream Course Requirements

1. Where any proposed Development or subdivision is within 30.0 m of a water body or a stream course, the Development Authority may require a study to determine the location of:
 - a. Flood Risk areas; and
 - b. Flood Fringe areas.
2. In the case of the lands Adjacent to Atim Creek where the Flood Risk areas are shown on Figure 3.11.1., the Development Authority may require a study to determine the location of Flood Fringe areas.
3. Notwithstanding any other provision of this Bylaw, where the study specified above indicates the presence of Flood Risk and Flood Fringe areas, the Development Authority may:
 - a. not permit any new buildings or other structures, or storage in the Flood Risk area;
 - b. allow land to be improved to provide an opportunity for Development where:
 - i. a deeper channel that ensures adequate storage capacity is constructed;
 - ii. a drainage outlet with mitigation to achieve no net loss of flood storage is constructed; and
 - iii. reclamation and naturalization of the drainage channel to re-establish riparian areas is constructed;
 - c. required that all windows and opening in new buildings within the Flood Fringe area be located a minimum of 0.50 m in elevation above the 1 in 100-year flood level;
 - d. require the determination of a safe building elevation; and
 - e. require a stormwater drainage plan be established.

Figure 3.11.1. – Flood Risk Area Adjacent to Atim Creek

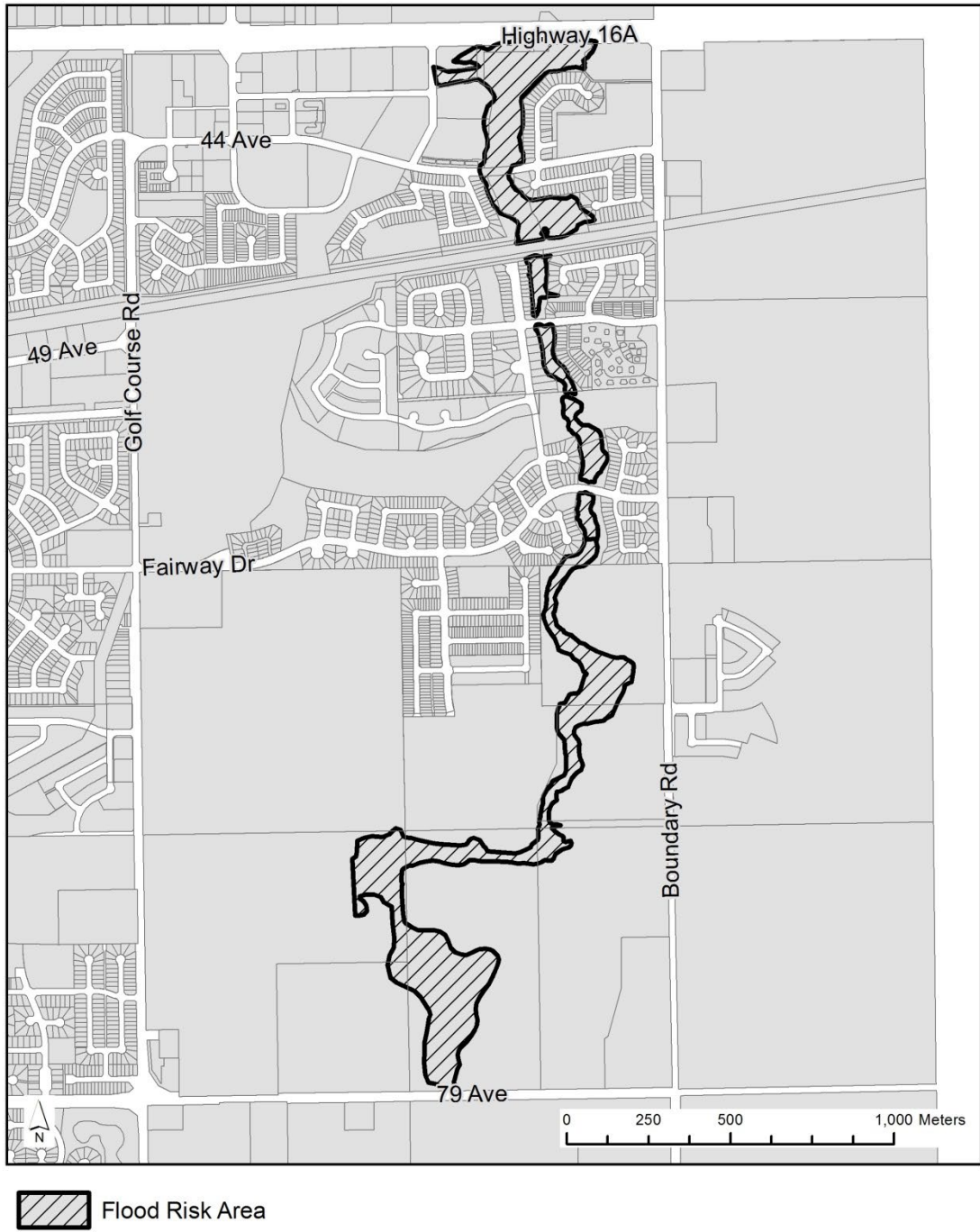

3.12.0. Proximity to a Well Site, Pipeline or Utility Easement

3.12.1. Proximity to a Well Site, Pipeline or Utility Easement Requirements

1. No building or structure or foundation of any kind is allowed within:
 - a. 5.0 m of an easement or right of way containing a major intermunicipal pipeline; except where a greater setback is required by a provincial or federal regulatory having jurisdiction.
2. Subject to the terms in a utility easement, no structure other than a Fence may be constructed or placed on that utility easement unless:
 - a. written consent has been obtained from the person for whose use the easement has been granted; and
 - b. the proposed structure does not restrict access to the utility easement for the purpose of installation and maintenance of the utility in the opinion of the Development Authority.

Use Classes

3.13.0. Campgrounds

3.13.1. Campground Regulations

1. A comprehensive site development and servicing plan is required for a Campground and must show the location of all campsites.
2. Internal roads for Campgrounds must be a minimum of 8.0 m wide and be finished to an all-weather standard.
3. Each Recreational Vehicle parking stall must be finished to an all-weather standard.
4. Traffic control and directional signage must be provided on-site to direct traffic internal traffic.
5. Two queuing spaces must be provided at the office with a minimum length of 12.0 m and width of 4.0 m to accommodate large vehicles.
6. A minimum of 10% of the Site area must be provided for common amenity space.
7. Pedestrian walkways must have a minimum width of 1.2 m and connect campsites to all amenities.
8. A maximum of 50% of the campsites may be dedicated to year-round camping.
9. A General Accessory Development is not allowed within a campsite.
10. Connection to municipal services is required for the Site, where available.
11. Year-round campsites must be serviced with water and sewer connections.
12. Potable water must be available on-site for seasonal campsites.

3.14.0. Cannabis Production and Distribution Facility

3.14.1. Cannabis Production and Distribution Facility Regulations

1. For a Cannabis Production and Distribution Facility:
 - a. the owner or applicant must provide, as a condition of development permit, a copy of the current license and all subsequent license renewals for all activities associated with medical Cannabis production issued by the federal department with jurisdiction;
 - b. the owner or applicant must obtain all other approvals, permits, authorizations, consents or licenses that may be required to ensure compliance with applicable federal, provincial or municipal legislation;
 - c. all processes and functions of the Development must be fully enclosed within a stand-alone building, including but not limited to, all loading spaces and docks, garbage containers, storage and waste material;
 - d. the Development must be a singular use and may not be operated in conjunction with any other land uses;
 - e. the Development must include equipment designed and intended to remove odours from the air where it is discharged from the building as part of a ventilation system;
 - f. the Development must be located a minimum of 100 m from a residential district;
 - g. the Development Authority may require, as a condition of development permit, a waste management plan, completed by a qualified professional that includes details regarding:
 - i. the incineration of waste products and airborne emissions, including odours;
 - ii. the quantity and characteristics of liquid and waste material discharged by the facility; and
 - iii. the method and location of collection and disposal of liquid and waste material;
 - h. the minimum number of parking stalls will be based on the requirements for a single industrial use as per Table 4.1.1.b.;
 - i. fencing of the Site is required, subject to the provisions of Section 3.22.1.;
 - j. medical Cannabis production facilities must not be constructed with a zero Lot Line;
 - k. notwithstanding the provisions of Part 5 Sign Regulations, no sign may be displayed on the Site that identifies the use; and
 - l. the Development may be subject to periodic inspections to ensure compliance with this Bylaw, the approved development permit and other municipal bylaws.

3.15.0. Cannabis Retail Sales

3.15.1. Cannabis Retail Sale Regulations

1. Any Site containing Cannabis Retail Sales must be located a minimum of 100 m from any Site being used as a public or private education services or a provincial health care facility at the time of the application for a development permit for Cannabis Retail Sales, and for the purposes of this subsection only:
 - a. the term “public or private education services” is limited to early childhood education, and elementary through to high schools inclusively, and does not include Child Care Services, dance schools, driving schools or other commercial schools; and
 - b. the 100 m separation distance will be measured from the closest point of any Site being used as a public or private education service or provincial health care facility property boundary to the closest point of the primary access to the Cannabis Retail Sales unit in the building in which the Cannabis Retail Sales unit is located, and may not be measured from the district boundaries.
2. Notwithstanding Section 1.2.2., a Development Authority may not grant a variance to subsection Section 3.15.1.1.
3. Prior to the issuance of a development permit, the Development Authority may conduct a Site assessment, taking into account land use impacts including, but not limited to, exterior illumination, landscaping, screening, signs and access.
4. The Development Authority may require lighting, signage, landscaping or screening measures that ensure the proposed Development is compatible with Adjacent or nearby residential, commercial, industrial or community services uses.
5. The Development Authority will impose conditions on every development permit issued for Cannabis Retail Sales requiring that the Development:
 - a. may commence once legalized and authorized by and compliant with federal or provincial legislation; and
 - b. must commence within six months of the date of approval of the development permit or the development permit becomes void and re-application is required.
6. For the purpose of Section 3.15.5., Development commences when the Cannabis Retail Sales use is established or begins operation.

3.16.0. Earthworks

3.16.1. Earthwork Requirements

1. Notice of an approved development permit for Earthworks may be mailed to all landowners within 30.0 m of the Site or Lot or whose property the Development Authority believes may be affected by the decision.
2. Earthworks is not permitted on a Site or Lot less than 0.2 ha in area.
3. Earthworks will not adversely affect the subject or adjacent properties.
4. Earthworks will be undertaken in a manner which mitigates the exposure of loose soil and the creation of dust or airborne debris.

3.17.0. Major Home Occupations

3.17.1. Major Home Occupation Regulations

1. A Major Home Occupation:
 - a. must be incidental and subordinate to the principal residential use of the dwelling and must not change the external appearance or character of the dwelling or the residential character of the area;
 - b. may not be a source of noise, vibration, smoke, dust, odour, heat or glare that is unsuitable for a residential use and would be more appropriately located in a commercial or industrial district;
 - c. may not occupy more than 25% of the total gross floor area of all the buildings on the Site, to a maximum of 40.0 m²;
 - d. must be conducted entirely within the principal dwelling or accessory development;
 - e. may not include outdoor storage of equipment, materials, commodities, or finished products;
 - f. may have a maximum of one business related utility trailer with a maximum length of 6.0 m, including the hitch, parked on the Lot at one time;
 - g. requires one additional parking space be provided on the Lot;
 - h. may involve direct retail sales or services from the premise;
 - i. will not be allowed on a Lot with an Accessory Dwelling or a Family Day Home, except in the C3 – Central Mixed Use District;
 - j. will not be approved on a Lot which has an existing approved Development Permit for a Major Home Occupation;
 - k. does not include any type of Automotive and Recreational Vehicle Sales and Service, repair or industrial type business;
 - l. does not include a Cannabis Retail Sales or a Cannabis Production and Distribution Facility; and
 - m. may have a maximum of one business related vehicle parked on the Lot at one time.
2. Where an additional parking space is required for a Major Home Occupation, that parking space must be made available to the clients for that Major Home Occupation during the hours in which the business is operating.
3. There must be no storage of dangerous or hazardous goods which would not reasonably be used in association with the residential use of the dwelling.
4. No commodity other than the product or service of the Major Home Occupation may be sold on the premises.
5. Except for a resident of the dwelling, no employee of a Major Home Occupation may undertake any work at the dwelling or park a vehicle on the Lot where the Major Home Occupation is located.
6. The Development Authority may place conditions including but not limited to hours and days of operation to mitigate or remove inconvenience to Adjacent landowners.

3.18.0. Residential Sale Centres

3.18.1. Residential Sale Centre Regulations

1. A Residential Sale Centre may be allowed, subject to issuance of a development permit and may be subject to a development agreement in consideration to emergency access and limiting conversion of the Residential Sale Centre to a dwelling.
2. Where a Residential Sale Centre is proposed on land that is not fully serviced, it will be subject to a development agreement.
3. A Residential Sale Centre must meet the Setback regulations of the district it is located within.
4. The appearance of the Residential Sale Centre must be maintained in an aesthetically pleasing manner.
5. The Site on which the Residential Sale Centre is located must be maintained in an orderly manner and will provide hard surface access for pedestrians accessing the Site.
6. Required parking must be provided on Site.
7. A development permit application for a Residential Sale Centre will include:
 - a. a site plan showing the proposed building location, dimensions, and Setbacks;
 - b. elevation drawings, including building height;
 - c. details for proposed parking with dimensions of parking stalls; and
 - d. location of exterior lighting.
8. In the case of a portable or mobile Residential Sale Centre:
 - a. the building may operate as a Residential Sale Centre for a period not exceeding 24 months unless an extension is granted by the Development Authority; and
 - b. the structure must be removed within 24 hours of the expiration of a development permit.

3.19.0. Surveillance Suites

3.19.1. Surveillance Suite Regulations

1. Only one Surveillance Suite Accessory Development is allowed per Lot.
2. The maximum floor area of a Surveillance Suite Accessory Development is 100 m².
3. A Surveillance Suite Accessory Development may only be used accessory to an approved Principal Use on the Site that is not a Temporary Development.
4. A Surveillance Suite Accessory Development will only be approved to provide an accommodation where the occupant of the Surveillance Suite Accessory Development performs a security function that is necessary for the operation of the Principal Use or building.
5. Where a Surveillance Suite Accessory Development is not part of the principal building, it must be placed in accordance with the following:
 - a. a minimum of 2.0 m from any buildings;
 - b. a minimum of 2.4 m from the Rear Lot Line;
 - c. must not be located within the Front Yard;
 - d. must not be located within a Side Yard Setback; and
 - e. must not obstruct access to the rear of the Site.

Accessory Development

3.20.0. Accessory Development

3.20.1. General Accessory Development Regulations

1. A General Accessory Development, as defined in this Bylaw, is allowed in a district when accessory to a Principal Use prescribed within a district for which a development permit has been issued.
2. The combined Lot Coverage of one or more principal buildings and any General Accessory Development must not exceed the Lot Coverage of that district.
3. Any General Accessory Development that has an area greater than 10.0 m² will require a development permit.
4. A General Accessory Development may not be used for human occupancy unless it is approved as an Accessory Dwelling or Surveillance Suite Accessory Development.
5. A non-residential General Accessory Development may be located within a Side Yard as long as it does not impede access to the rear of the property;
6. No General Accessory Development may be located in the Front or Flankage Yard unless otherwise specified in this Bylaw.
7. Notwithstanding any other provision of this Bylaw, a shipping container may be considered a General Accessory Development for the purpose of temporary storage and transportation and allowed for up to 30 days in residential and commercial districts if it meets Side Yard Setbacks and does not impact more than one on-site parking space.
8. A Swimming Pool is a type of General Accessory Development and will:
 - a. not be located within any required Front Yard;
 - b. have the water surface be a minimum of 1.5 m from a Lot Line; and
 - c. not have diving boards, slides and other accessory uses encroach onto the Setback requirements.
9. A playhouse, play equipment, gazebo, other outdoor structure or combination of any of these is a type of General Accessory Developments and will:
 - a. not be located less than 1.0 m from the side or Rear Lot Lines;
 - b. not encroach on Front Yard Setbacks; and
 - c. not be more than 4.0 m in height.

3.20.2. General Accessory Development Regulations for Low and Medium Density Residential Uses

1. No General Accessory Development may be located:
 - a. in a Front Yard; or
 - b. within a Side Yard Setback from the principal building.
2. The maximum height of a General Accessory Development that is 10.0 m² or less in area is 4.0 m.
3. The maximum height of a General Accessory Development that is greater than 10.0 m² is the lesser of:
 - a. 4.6 m; or
 - b. the height of the principal building on the Site in which it is located.
4. No person may construct or allow the construction of a General Accessory Development, or group of General Accessory Developments, such that, individually or collectively, the gross floor area would:
 - a. along with the principal building, exceed the maximum Lot Coverage allowed on the Lot;

- b. exceed the gross floor area of the principal building on the Lot; or
 - c. exceed 20% of the Site area.
5. Minimum Setback requirements for a General Accessory Development are as follows:
- a. 1.0 m from the Rear Lot Line;
 - b. 1.0 m from the Side Lot Line, this may be reduced to 0.0 m from the Side Lot Line where Section 3.25.1 applies.
 - c. 2.0 m from the principal building; and
 - d. No closer to the road than the front line of the principal building, except in the case of a double fronting or Corner Lot with two Front Yards or a Front Yard and a Flankage Yard where:
 - i. a Setback of 3.0 m is allowed from one Front Lot Line; and
 - ii. a Setback of 7.5 m is allowed from the curb on one Front Lot Line.
6. The Setback requirements for a rear detached garage General Accessory Development are as shown in Figure 3.20.2.

Figure 3.20.2. – Minimum Setback requirements for Rear Detached Garages

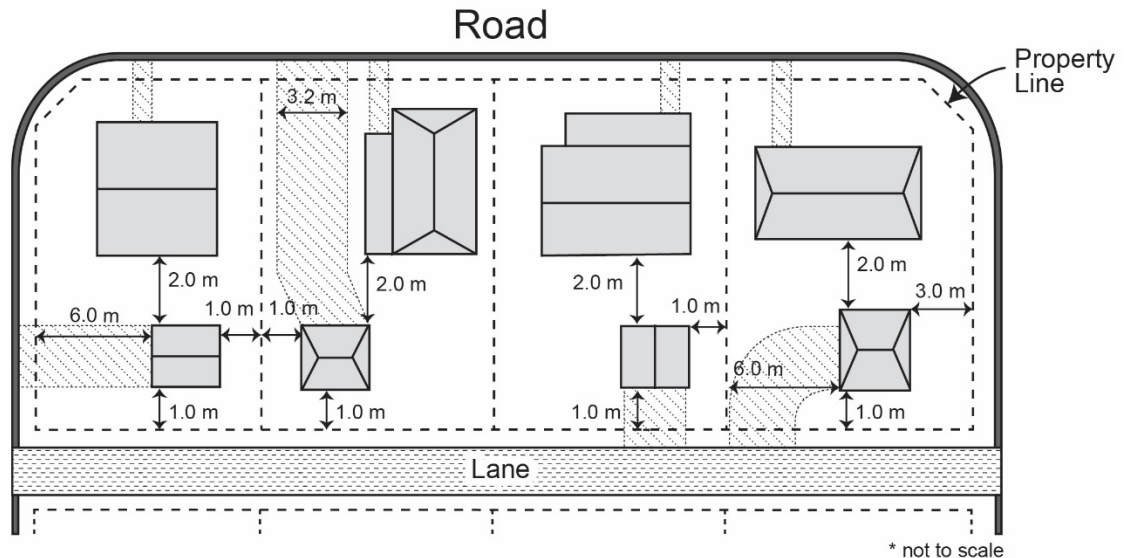

3.20.3. General Accessory Development Regulations for Public, Commercial and High Density Residential Uses

1. No General Accessory Development may:
 - a. be located within a front or Side Yard Setback;
 - b. be located within 1.0 m from the Rear Yard Lot Line;
 - c. be located within 2.0 m of a principal building;
 - d. eliminate or interfere with parking, loading or the manoeuvring of vehicles or pedestrians on the Site; or
 - e. interfere with a vehicle or pedestrian sightline.
2. The maximum height of a General Accessory Development must not exceed 10.0 m.

3.20.4. General Accessory Development Regulations for Other Uses

1. A General Accessory Development may not:
 - a. be located within a Front Yard or Side Yard Setback;

- b. be located within a minimum of 2.4 m from the Rear Lot Line;
 - c. eliminate or interfere with parking, loading or the manoeuvring of vehicles or pedestrians on the Site; and
 - d. interfere with a vehicle or pedestrian sightline.
2. The maximum height of a General Accessory Development for an industrial use is the lesser of:
 - a. 20 m; or
 - b. the height of the principal building on the Site in which it is located.
 3. The maximum height of a General Accessory Development in the FD – Future Development District is 12.0 m except where the use of a General Accessory Development is Rural Farm or Indoor Farm.

3.20.5. Outdoor Display Area Accessory Development Regulations

1. Where any commercial or industrial Development involves an Outdoor Display Area Accessory Development, the Outdoor Display Area Accessory Development may not:
 - a. be located on municipal property;
 - b. be located on a Site that includes a residential use;
 - c. obstruct a pedestrian walkway or motor vehicle drive aisle;
 - d. be located within 2.0 m of a Lot Line; or
 - e. be placed over any Landscape area.

3.20.6. Outdoor Storage Accessory Development Regulations

1. Where any industrial Development involves Outdoor Storage Accessory Development, other than an Outdoor Display Area Accessory Development:
 - a. a wooden Fence or other product of equal screening value must be constructed to a minimum of 1.8 m and a maximum of 2.4 m in height to screen where any industrial or commercial outdoor storage Abuts or is Adjacent to a residential district;
 - b. a wooden Fence or other product of equal screening value may be required to be constructed to a minimum of 1.8 m and a maximum of 2.4 m in height to screen where any industrial or commercial outdoor storage Abuts a public road;
 - c. the Outdoor Storage Accessory Development:
 - i. must not be located within a Front Yard;
 - ii. must not interfere with pedestrian or vehicular circulation or use any required parking stalls; and
 - iii. may include the storage of empty shipping containers on a Lot within the M1 – Business Industrial District.

3.20.7. Prefabricated Structure Accessory Development Regulations

1. A Prefabricated Structure Accessory Development:
 - a. will be considered an accessory development to the principal building on the Lot;
 - b. must not exceed the maximum height requirement for that land use district; and
 - c. must not be located in front of the principal building.

3.20.8. Shipping Container Accessory Development Regulations

1. A Shipping Container Accessory Development:
 - a. will be considered an accessory development to the non-residential Principal Use of the Lot;
 - b. may not be allowed to be stacked;
 - c. may not be allowed in the Front Yard or Flankage Yard;
 - d. may not prohibit vehicular access to the Rear Yard;

- e. will be used for storage purposes only, excluding any dangerous or hazardous materials or containers; and
 - i. must have an exterior finish that matches or compliments the exterior finish of the Principal Use; or
 - ii. must be screened from view.
- 2. The maximum size allowed in the C2 – General Commercial District and C3 – Central Mixed Use District is 6.5 m by 2.5 m.

3.21.0. Accessory Dwelling

3.21.1. General Regulations

1. The gross floor area of an Accessory Dwelling will be less than the gross floor area of the principal building.
2. An Accessory Dwelling may be located within either:
 - a. a principal building; or
 - b. a General Accessory Development with a permanent foundation.
3. An Accessory Dwelling requires one additional on-site parking space.
4. An Accessory Dwelling is not allowed within a Recreational Vehicle or Park Model.
5. An Accessory Dwelling is not allowed on a Lot with a Major Home Occupation, except in the C3 – Central Mixed Use District.
6. Notwithstanding the density regulations in an underlying district, one additional Accessory Dwelling is allowed within Districts where Accessory Dwellings are Permitted or Discretionary, for a Lot located within the Old Town Community Plan area.

3.21.2. Accessory Dwellings within a General Accessory Development

1. Where an Accessory Dwelling is located within a General Accessory Development:
 - a. The General Accessory Development containing the Accessory Dwelling must have either:
 - i. direct access to a lane or road; or
 - ii. a 3.2 m wide driveway access to the General Accessory Development containing the Accessory Dwelling.
 - b. the distance between the principal building and the General Accessory Development containing the Accessory Dwelling must be a minimum of 3.0 m;
 - c. the distance between the General Accessory Development containing the Accessory Dwelling and the Rear Lot Line must be a minimum of 1.5 m;
 - d. the General Accessory Development containing the Accessory Dwelling must meet the required Side Yard Setbacks for a principal building of the district in which it is located; and
 - e. the General Accessory Development must be finished in a similar manner that will complement the principal building on the Site.
2. Notwithstanding any General Accessory Development height regulations, the maximum height of a General Accessory Development where an Accessory Dwelling is located above a detached garage is 8.0 m.
3. Notwithstanding Section 3.21.2.1.b., if an Accessory Dwelling is added to an existing General Accessory Development, the required minimum distance between the principal building and the General Accessory Development containing the Accessory Dwelling is 2.0 m.
4. Notwithstanding Sections 3.21.2.1.c. and 3.21.2.1.d., if an Accessory Dwelling is added to an existing General Accessory Development, the required minimum Rear Yard and Side Yard Setbacks for the General Accessory Development containing the Accessory Dwelling are 1.0 m.
5. A balcony may be allowed as part of an Accessory Dwelling above a garage provided that:
 - a. it faces a rear lane or flanking road; and
 - b. it meets the required Setbacks in Section 3.21.2.1. above.
6. Windows must be placed and sized so that they minimize overlooking into the Yards and windows of Abutting properties by:
 - a. offsetting window placement to limit direct views into the Rear Yard or Side Yard of Abutting properties;

- b. placing windows in conjunction with landscaping and other General Accessory Developments either on-site or Adjacent to the Site; and
- c. placing larger windows so that they face the lane and flanking road.

3.22.0. Fencing

3.22.1. Fencing Regulations

1. A Fence may not be located on public property without permission from the Municipality.
2. The maximum height of a Fence must not exceed 1.0 m within the sight line controls of Section 3.6.1.
3. The maximum height of a Fence above grade in any district is based upon the Yard in which it is located (see Figure 3.8.1. for Yard types) where the maximum height is described below and shown in Figure 3.22.1.:
 - a. 1.0 m in the Front Yard;
 - b. 1.0 m in a Flankage Yard that, or portion of a Flankage Yard where it, Abuts a Front Yard or driveway;
 - c. Notwithstanding Section 3.22.1.3.b., 1.8 m in a Flankage Yard may be allowed if the fence is constructed a minimum of 1.2 m from the Flankage Lot Line; and
 - d. 1.8 m for all other Yards.

Figure 3.22.1. – Fencing

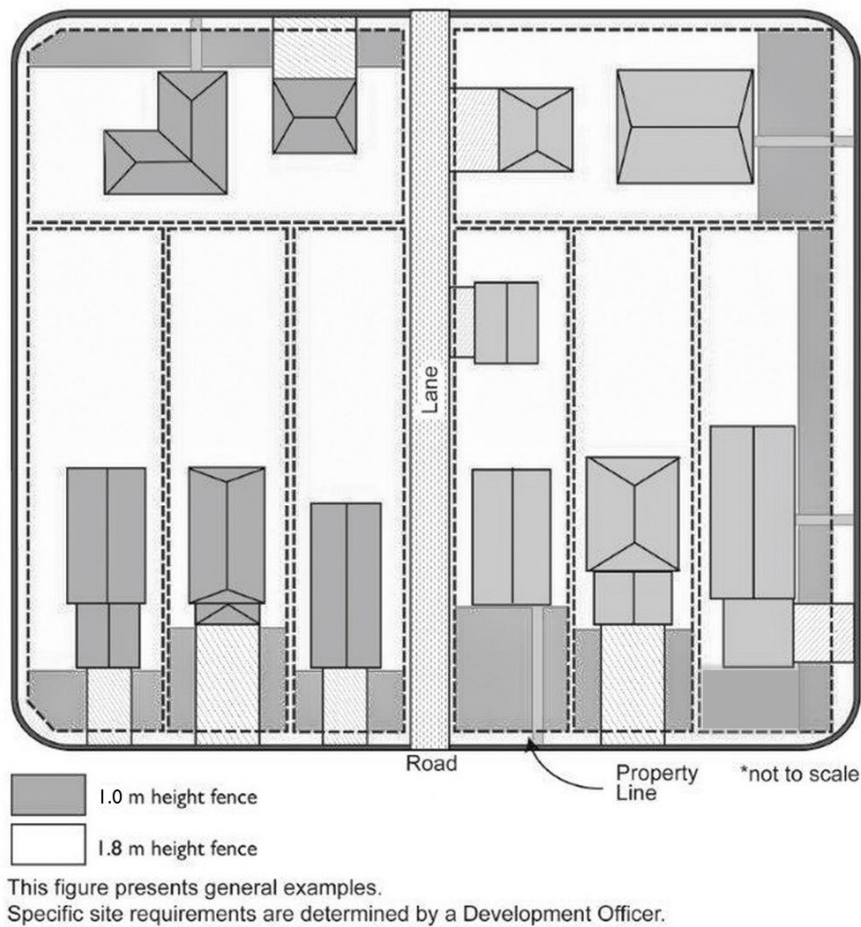

4. The Development Authority may approve a Fence greater in height than 1.8 m:
 - a. in the M1 – Business Industrial District or the FD – Future Development District; or

- b. where a Lot in a residential district Abuts an arterial road, a railway right of way, a Lot with an industrial use or a non-residential use within the FD – Future Development District.
- 5. No barbed wire Fences will be allowed in residential districts or in other districts that Abut a residential district, with the exception of the FD – Future Development District.
- 6. No razor wire Fences will be allowed in any districts.
- 7. Electrical Fences will only be allowed in the FD – Future Development District.

Buildings

3.23.0. Building Facades

3.23.1. Building Façade Regulations

1. Any Facade of a building facing a road must incorporate more than one colour and at least one feature, which may include but is not limited to a texture, material or design element.
2. The Facade of a building must be completed prior to the expiry of the development permit.

3.24.0. Relocation of Buildings

3.24.1. Requirements for Relocating a Building

1. Where any building is to be relocated to a new Lot or relocated within the same Lot:
 - a. a development permit is required for the lands on which it will be located; and
 - b. the location of such building must conform to the district in which it is relocated.

Zero Lot Line

3.25.0. Zero Lot Line Development

3.25.1. Zero Lot Line Development Regulations

1. Zero lot line development is permitted solely within the R2 – Detached Dwelling Residential District, R4 – Mixed Form Residential District, R5 – Small Lot Mixed-Form Residential District, R6 – Comprehensively Planned Residential District (Option B).
2. A block plan must be approved by the Development Authority prior to a related application being deemed as complete where the block plan must provide:
 - a. a contiguous area along a road right of way showing all lots on either side of the road right of way;
 - b. the location of all maintenance easements required, as per Section 3.25.1.7.; and
 - c. each proposed residential Lot and indicate the dwelling type as either Detached Dwelling, Semi-Detached Dwelling or Row House Dwelling for each lot.
3. For a block plan required as per Section 3.25.1.2., the dwelling type assigned to each proposed residential Lot may be revised if such a change allows the plan to continue to meet all the regulations required within this section and a revised plan is approved by the Development Authority
4. Zero lot line development must comply with the regulations of the underlying district, except that:
 - a. the Flankage Yard Setback is 2.4 m to the principal building;
 - b. in the R2 – Detached Dwelling District, if one Side Yard Setback is increased to a minimum of 2.4 m to the principal building, the other Side Yard Setback may be reduced to a minimum of 0 m to the principal building;
 - c. in the R4 – Mixed Form Residential District, R5 – Small Lot Mixed-Form Residential District, and R6 – Comprehensively Planned Residential District (Option B), if one Side Yard Setback is increased to 1.5 m to the principal building, the other Side Yard Setback may be reduced to a minimum of 0 m to the principal building and the Lot Width minimum is reduced by 0.9 m;
 - d. in the R4 – Mixed Form Residential District and R5 – Small Lot Mixed-Form Residential District, the minimum Lot Area is reduced by 30 m²; and
 - e. in the R6 – Comprehensively Planned Residential District (Option B), the minimum Lot Area is reduced by 20 m².
 - f. any General Accessory Development that is a detached garage accessed from a lane, may be constructed on the same 0.0 m Side Yard Setback as the principal building.
5. All roof drainage from the Dwelling, including an attached garage, and General Accessory Development Buildings, will be directed away from buildings and towards a public road, a lane, or a drainage feature, such as a swale.
6. No roof leader discharge will be directed to the maintenance easement.
7. The owner of a Lot within a Development proposed for zero lot line development and the owner of the Abutting Lot must register, on land titles for all Adjacent Lots:
 - a. a 1.5 m private maintenance easement that requires:
 - i. an unobstructed minimum width drainage pathway of 0.3 m to be free and clear of all objects;
 - ii. when the distance between principal buildings is 2.4 m, a 0.6 m eave encroachment easement where the eaves can be no closer than 1.2 m to the eaves on the building of the Adjacent Lot;

- iii. when the distance between principal buildings is 1.5 m, a 0.3 m eave encroachment easement where the eaves can be no closer than 0.9 m to the eaves on the building of the Adjacent Lot;
 - iv. a 0.6 m footing encroachment easement;
 - v. permission to access the easement area for maintenance purposes; and
 - vi. that any General Accessory Development building, including a detached garage, will not encroach on the private maintenance easement, except that the eaves of a detached garage may encroach up to 0.3 m into the private maintenance easement where 3.25.1.4.f. applies; and
- b. a restrictive covenant and easement that:
- i. requires a drainage swale constructed per Section 3.25.10. of the Land Use Bylaw; and
 - ii. provides for the protection of Site drainage, including the right for water to flow across Lots and the requirement to not inhibit the flow of water across Lots.
8. Zero lot line developments with front drive access will not be located:
- a. directly across a public road, other than a lane, from another zero lot line development with front drive access; or
 - b. on major collector roads.
9. Zero lot line development will only be permitted for a Detached Dwelling Use.
10. Zero lot line development requires the construction and maintenance of a drainage swale within a 1.5 m private maintenance easement as generally shown in Figure 3.25.1. and where:
- a. the swale is within the easement;
 - b. the swale is a minimum of 1.5 m;
 - c. the swale is a minimum depth of 0.15 m when the swale is adjacent to a building;
 - d. the swale has a minimum slope of 10%; and
 - e. roof leader discharge is directed away from the maintenance easement.
11. Zero lot line development is only allowed where shown in Figure 3.25.13.

Figure 3.25.1. Swale Cross Section for Zero Lot Line Development

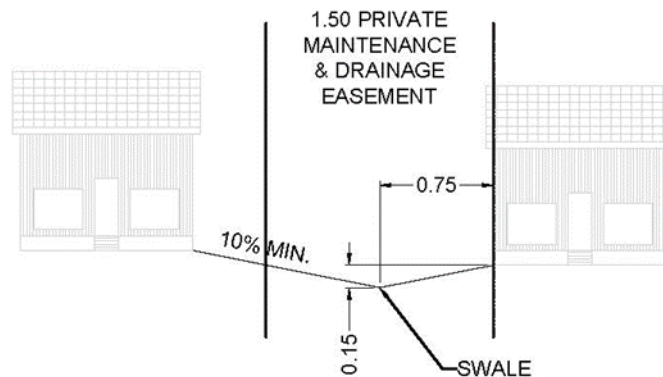
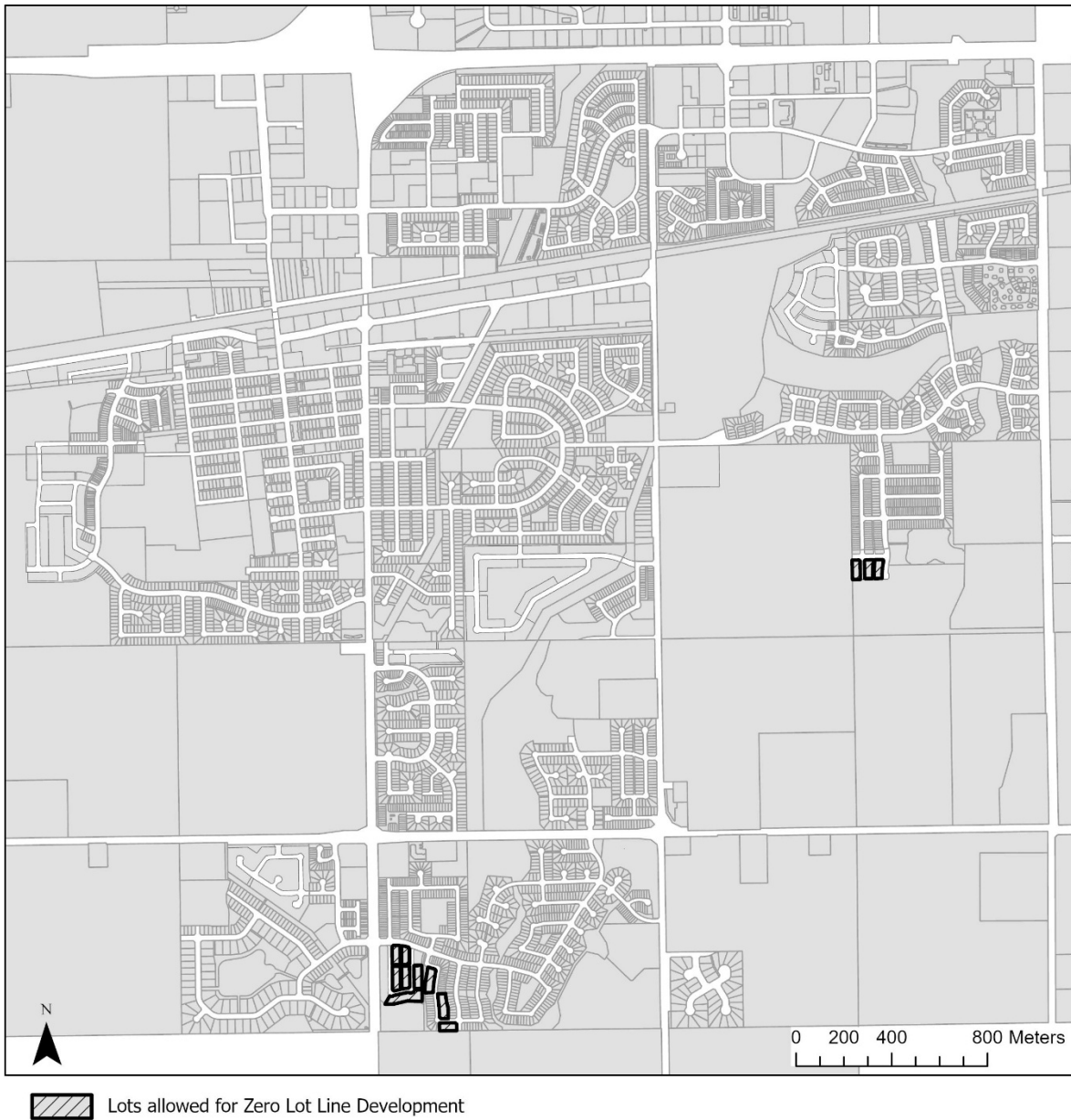

Figure 3.25.13. Lots Allowed for Zero Lot Line Development



PART 4 - PARKING & ACCESS REGULATIONS

4.1.0. Parking Regulations

4.1.1. General Parking Requirements

1. The minimum off-street parking requirements apply to any Development, whether a new building, an enlargement or addition to an existing building, except for:
 - a. a change of use in an existing Development; or
 - b. a new Development within the C3 – Central Mixed Use District, where:
 - i. one parking space per Dwelling Unit must be provided for residential uses; and
 - ii. no parking is required for all other uses.
2. The minimum off-street parking requirements for each land use are identified in the following tables:
 - a. residential uses as specified in Table 4.1.1.a.; and
 - b. non-residential uses as specified in Table 4.1.1.b.
3. Where the parking requirements of a land use are not specified in this Bylaw, the Development Authority will be guided by the standards for similar uses.
4. The required number of spaces for a Development is the sum of the requirements for every instance of every use within a Development.
5. Where a fractional number of parking spaces are required by this Bylaw, the required number of stalls will be rounded up to the next number.
6. The number of parking stalls required may be reduced where the parking required by various users on a Site or Lot will vary according to the time when the businesses are in operation during a 24-hour period so that all needs can be met.
7. In any residential district, no Front Yard may be used for parking of any commercial vehicle in excess of 6000 kg gross vehicle weight.
8. No more than one commercial vehicle, which is greater than 6000 kg gross vehicle weight, bus, or trailer, may be parked in the Rear Yard within a residential district.
9. The minimum number of bicycle stalls required are:
 - a. four stalls for a commercial, educational, recreational and community Site or Lot; and
 - b. the higher of four stalls or one for every ten required vehicular parking stalls for a high density residential Site or Lot.
10. For a Recreational Vehicle in a residential district:
 - a. a Recreational Vehicle parking space is allowed and does not require a development permit if it is contained solely in the flankage, rear and Side Yards and does not encroach in the flankage or Side Yard Setbacks;
 - b. a development permit approval is required for a Recreational Vehicle parking space utilized between November 1 and March 31 for a period of more than seven days that does not meet the criteria of 4.1.1.10.a. and the approval is subject to the parking space:
 - i. being accessory to a principal residence;
 - ii. not impeding emergency access to any area on the Site or Lot; and
 - iii. not encroaching into any required Setbacks for the front or Side Yard within the district that the parking space would be located in;
 - c. a parked Recreational Vehicle must not encroach over a sidewalk or road right of way; and
 - d. there will be no more than one Recreational Vehicle per Lot.

Table 4.1.1.a – OFF-STREET PARKING REQUIREMENTS FOR RESIDENTIAL USES	
Use of Building or Lot	Minimum Number of Parking Spaces
Detached Dwelling Semi-Detached Dwelling Duplex Dwelling Row House Dwelling	2 spaces per Dwelling Unit, tandem parking is allowed
Multi-Unit Dwelling	1 space per Dwelling Unit containing 1 or fewer bedrooms, and 1.25 spaces per Dwelling Unit with 2 or more bedrooms, tandem parking is allowed to a maximum of 10%
Visitor parking in: Multi-Unit Dwelling Comprehensively planned residential sites	1 space per 10 Dwelling Units that will be clearly marked as visitor parking, tandem parking is not allowed
Long Term Care Facility	0.25 spaces per bed
Supportive Living Facility	0.6 spaces per unit
Visitor parking in: Long Term Care Facility Supportive Living Facility	0.2 spaces per Dwelling Unit or bed that will be clearly marked as visitor parking, tandem parking is not allowed
Live Work Unit Bed and Breakfast Accessory Dwelling Surveillance Suite Accessory Development Major Home Occupation	1 additional space

*minimum number of bicycle stalls for high density residential Sites is the higher of four stalls or one for every ten required vehicular parking stalls

*minimum number of parking spaces for affordable housing developments is determined by the use of the building or the lot

Table 4.1.1.b – OFF-STREET PARKING REQUIREMENTS FOR NON-RESIDENTIAL USES	
Use of Building or Lot	Minimum Number of Parking Spaces
Hotel, Motel	0.75 space per guest room
Bar, Community Facility, Food and Drink Service, Private Club, Religious Assembly, Hospital, Recreation Facility, or any commercial or industrial use not otherwise specified in this table	1 space per 50.0 m ² of gross floor area
A single industrial use	5 parking spaces
Elementary and junior high school	3 spaces per classroom
High school	15 spaces per classroom

*minimum number of bicycle stalls for commercial, educational, recreational and community Sites is four

4.2.0. Development Requirements for Parking Areas and Parking Facilities

4.2.1. General Regulations

1. Each parking space in the parking area must have the limits of the parking space clearly marked and such marking must be regularly maintained.
2. All required visitor parking stalls located on a multi-unit residential Development must be clearly identified with post mounted signage.
3. Internal private road widths for residential and mixed-use developments must be a minimum of 8.0 m.
4. Internal private road widths not intended to serve as a maneuvering aisle for a parking stall may be reduced to a minimum width of 6.0 m, where the reduced width does not impact vehicle turning movements and emergency vehicle access.
5. Where an off-street parking lot provides a parking area of 700 m² or greater, the parking spaces must be arranged within smaller sets by using pedestrian walkways, raised curbing, sidewalks, landscaping or any combination of these elements.
6. All off-street parking must be constructed so that:
 - a. necessary curb cuts are located and Flared to the satisfaction of the Development Authority;
 - b. all areas of a Site to which a vehicle has access, including parking facilities, parking areas and lanes, are hard-surfaced or paved with asphalt, concrete or another similar product;
 - c. parking facilities and parking areas used at night have adequate lighting for the entire Parking Facility and parking area and make use of focused light fixtures to direct light away from Adjacent properties and roads; and
 - d. drainage will be managed within the Site according to an approved lot grading plan.
7. 5% of all parking stalls may be provided as compact parking stalls, not including barrier free.

4.2.2. Minimum Parking Stall Dimensions

1. A motor vehicle parking stall not located in a parking Lot, garage or structure must be
 - a. a minimum of 6.0 m deep;
 - b. a minimum of 2.75 m wide; and
 - c. completely contained within a Lot, except for Lots within the R3 – Residential Park District where the stall may extend into the road right of way provided it does not cross a sidewalk or curb.
2. The minimum dimensions of parking stalls and manoeuvring aisles within a parking lot, garage or structure must be in accordance with Figure 4.2.2. and Table 4.2.2.
3. Where a manoeuvring aisle provides emergency service access to a building or structure with a 12.0 m or greater height, the Development Authority may require an additional 1.0 m of aisle width beyond the minimum aisle width specified in Figure 4.2.2. and Table 4.2.2.

Figure 4.2.2. - Minimum Parking Facility Dimensions

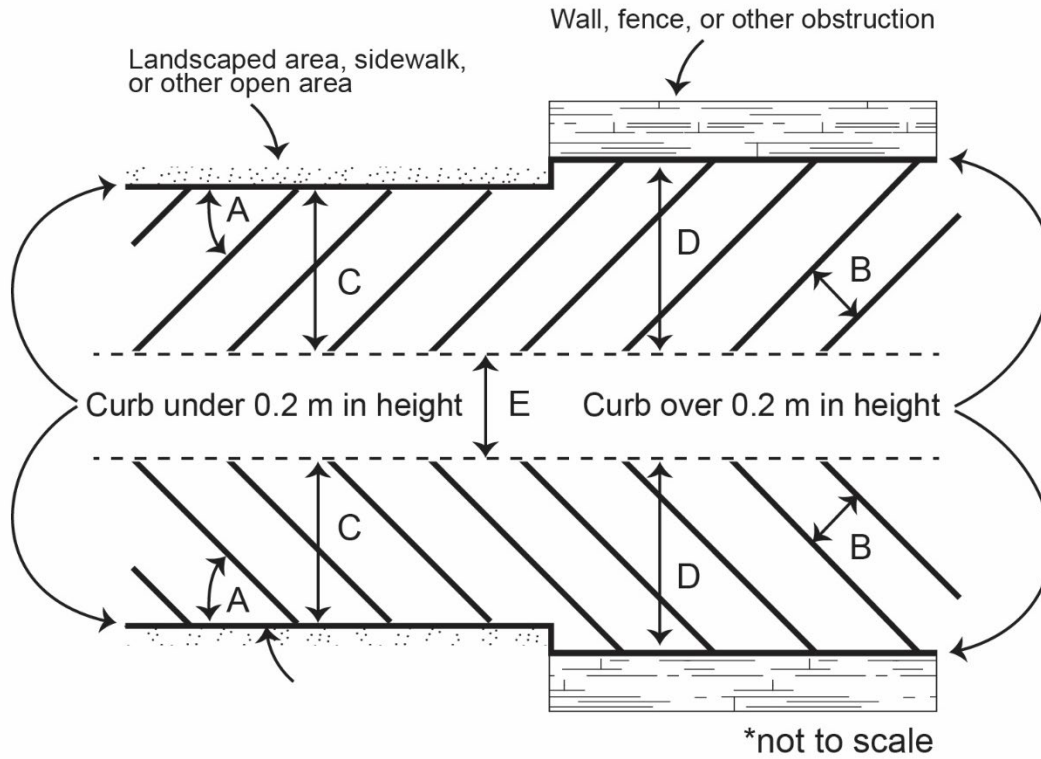

TABLE 4.2.2. - MINIMUM PARKING FACILITY DIMENSIONS						
Car size	-A- Angle of parking	-B- Minimum required stall width (m)	-C- Distance between aisle and curb overhang (m)	-D- Distance between aisle and curb over 0.20 m in height (m)	-E- Minimum aisle width (m)	
					One-way	Two-way
Standard	0°	2.75	2.75	3.0	4.0	7.0
Compact		2.5	2.5	2.8		
Standard	30°	2.75	5.2	5.3	4.5	---
Compact		2.5	4.6	4.6		
Standard	45°	2.75	5.9	6.1	5.0	---
Compact		2.5	5.2	5.2		
Standard	60°	2.75	6.2	6.4	6.0	---
Compact		2.5	5.5	5.5		
Standard	90°	2.75	5.6	5.8	7.0	7.0
Compact		2.5	4.9	4.9		

4.2.3. Barrier Free Parking

1. Barrier free parking must:
 - a. be provided in accordance with the Alberta Building Code;
 - b. be located as close as possible to building entrances;
 - c. not be in tandem;
 - d. not be in front of garages; and
 - e. be clearly designated with post mounted signage.

4.3.0.

Off-Street Loading Regulations

1. Each commercial, industrial, community and high density residential building:
 - a. must have one loading space; and
 - b. may be required to have additional loading spaces.
2. An Off-Street Loading space must be not less than 4.0 m in width and 8.0 m in length and have an overhead clearance of not less than 4.3 m above grade.
3. An Off-Street Loading space must:
 - a. be contained entirely within the Site;
 - b. be graded and drained within the Site;
 - c. be Hard Surfaced;
 - d. be adequately lit;
 - e. be screened on each side Abutting or fronting a property in a residential district by a wall, Fence or hedge of not less than 1.8 m in height;
 - f. be clearly designated with post mounted signage;
 - g. be located outside of any drive aisles, driveway access points and emergency vehicle access areas;
 - h. be located Adjacent to the building that it is intended to serve, or be located in an area where it is accessible;
 - i. allow for adequate area for delivery vehicles to maneuver; and
 - j. have unobstructed access to the entrance where loading is to occur.

4.4.0.

Queuing Requirements

1. For a development with a drive-through, a minimum of one queuing lane with a minimum of six in-bound queuing spaces must be provided for vehicles approaching the service window.
2. For a development with a drive-through that does not have a food service, one queuing lane with a minimum of two queuing spaces must be provided for vehicles approaching the service window.
3. For a development with a drive-through, one out-bound space must be provided on the exit side of the service window and must not interfere with other vehicular movements.
4. For a car wash or other establishment with more than one bay, each drive aisle must have:
 - a. a minimum of one in-bound stacking space per bay or three in-bound stacking spaces, whichever is greater; and
 - b. a minimum of two out-bound stacking spaces.
5. Each queuing space must be a minimum of 7.0 m long and 3.0 m wide.
6. Each queuing lane must provide sufficient space for turning and manoeuvring.
7. For a gas bar or a service station:
 - a. any fuel pump island must be located at least 6.0 m from any boundary of the Lot, a parking area on the Lot, or any lane intended to control traffic circulation on the Lot; and
 - b. a canopy over a pump island may extend to within 3.0 m of the boundary of the Lot.

4.5.0. Driveways and Access to Roads and Lanes

4.5.1. Private Residential Driveways

1. A residential Development will be allowed only one access to the Lot.
2. In no case should a private residential driveway be situated:
 - a. closer than 8.0 m from a point where the curbs of interacting roads would intersect if extended;
 - b. closer than 1.0 m from a Corner Lot line Adjacent to a lane; and
 - c. closer than 3.0 m from a community mailbox.
3. A driveway:
 - a. must be a minimum width of 3.2 m;
 - b. may be widened to incorporate a walkway to an entrance of a principal building;
 - c. in combination with any walkways must not exceed:
 - i. 85% of the Front Yard for Pie-Shaped Lots; or
 - ii. 80% of the Front Yard for all other types of Lots; and
 - d. may only be extended to the side Lot Line if it does not interfere with the required lot grading and drainage.
4. The parking of a vehicle may only be located on an approved driveway or parking stall.

Figure 4.5.1 – Residential Driveways and Accesses

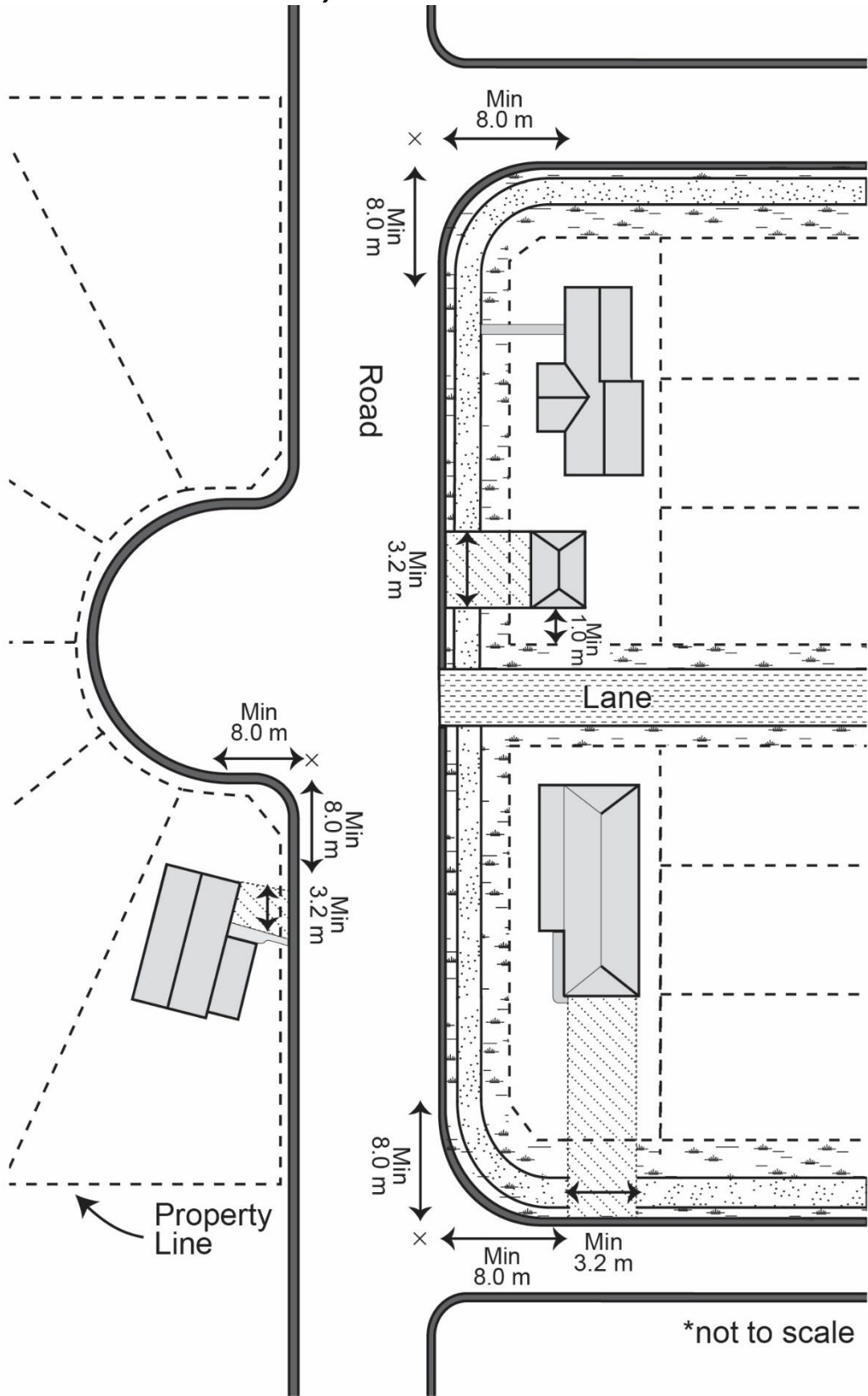

4.5.2. Parking Space with Direct Access to a Lane

1. Where there is no garage and any parking stall has direct access from a lane, the front of the parking stall must be no less than 7.5 m from the closest Lot Line Abutting the lane.

4.5.3. Access to Parking Areas for Multi-Unit Residential, Commercial, Industrial and Community Districts

1. A Development is allowed either:
 - a. one two-way driveway crossing per frontage;
 - b. two one-way driveway crossings per frontage; or
 - c. where a frontage is greater than 50 m, two two-way driveway crossings per frontage.
2. An additional access may be allowed based on the nature and size of the Development, anticipated traffic generation and the design and configuration of the road where an additional access is proposed.
3. A shared two-way access between two Adjacent Sites is allowed.
4. A required access or curb cut must be located and Flared to the satisfaction of the Development Authority and be constructed to the following standards:
 - a. a driveway must not be situated:
 - i. closer than 10.0 m from a Corner Lot line Adjacent to an intersection; and
 - ii. closer than 3.0 m from a side property line or lane, except for shared accesses;
 - b. a two-way driveway will be positioned at 90 degrees to the road, except for particular uses, where the Development Authority may approve an angled driveway, and the minimum width of a Flare of a two-way driveway must be 1.5 m where the Flare meets the curb of the road;
 - c. a one-way driveway must be angled in the direction of entry or exit and be properly signed; and
 - d. the minimum distance between driveways on the same boundary of the Site may not be less than 6.0 m where the distance may be reduced when a shorter distance would be necessary for reasons of public safety or convenience.
5. A driveway width for an access to a multi-unit residential, commercial, industrial, community and Park use must be between 7.5 m and 12.5 m.

Figure 4.5.3 – Access to Parking Areas for Multi-Unit Residential, Commercial, Industrial and Community Sites

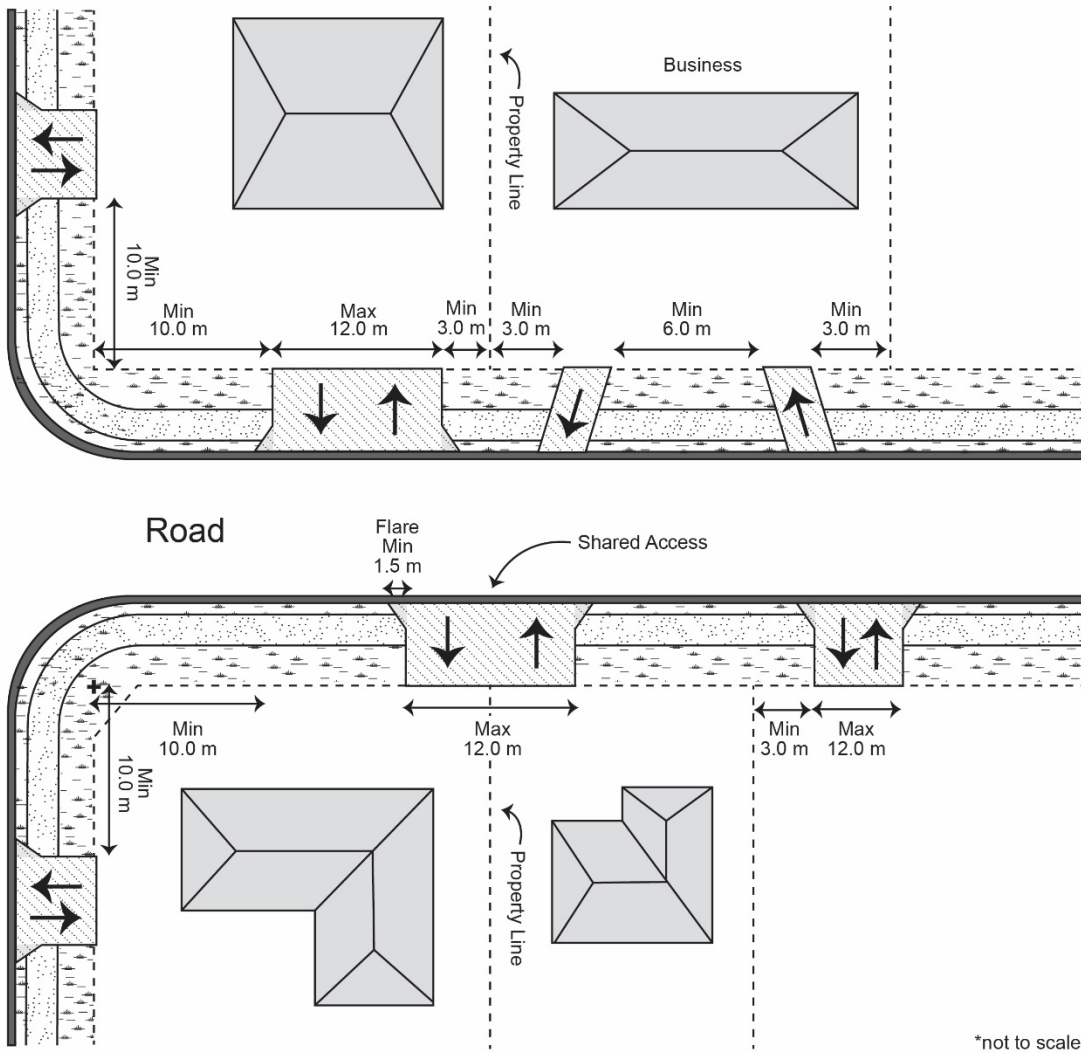

PART 5 - SIGN REGULATIONS

5.1.0. Regulations for a Development Permit for a Sign

5.1.1. Requirements for a Development Permit for a Sign

1. Except as provided in Section 5.1.2., no sign may be erected on land or affixed to any exterior surface of a building or structure unless a development permit for the sign is issued by the Development Authority.

5.1.2. Exemption from a Development Permit for a Sign

1. The following sign types do not require a development permit for their erection or display if they meet the regulations specified in Table 5.2.0.a. and Table 5.2.0.b. and otherwise comply with the requirements of this Bylaw:
 - a. alterations which do not change the structural or physical dimensions of the sign;
 - b. any sign posted in or on a registered and licensed motor vehicle;
 - c. any sign displaying a yard or garage sale, provided it is located on the Site in which the sale is to occur, and is placed not more than seven days prior to the sale date and is removed at the end of the sale date;
 - d. a temporary holiday sign or decoration provided it is removed within seven days of the season or holiday it depicts;
 - e. a sign erected on municipal property by the Municipality;
 - f. a sign not exceeding 0.50 m² in area which identifies the name or address of the occupant of a dwelling;
 - g. a sign not exceeding 0.50 m² in area which advises of restrictions on the use of a building or Site, such as a “no parking” or “no trespassing” sign;
 - h. a real estate sign not exceeding 1.0 m² in area in any residential district except for the R8 – High Density Residential District, and not exceeding 5.0 m² in area in any other district including the R8 – High Density Residential District;
 - i. a directional sign not exceeding 1.0 m² in area which indicates the direction or function of various parts of a building or Site, including parking and traffic areas;
 - j. a window sign in any non-residential district that does not exceed 40% of the area of the window in which it is placed, and does not exceed 5.0 m² in area regardless of the size of the window;
 - k. a sign not exceeding 9.0 m² in area for the purpose of advising the public of future or ongoing Development, construction, or subdivision of a building or Site provided it is removed within 30 days after the work is complete;
 - l. a sign erected by or at the direction of a government including signs identifying public buildings, giving information to the public or regulating traffic or safety;
 - m. a flag, insignia, notice or advertising of any charitable, religious or fraternal organization if it does not exceed 0.50 m² in area in a district that allows dwellings as Permitted Use, or does not exceed 3.0 m² in area in all other districts;
 - n. a mural;
 - o. an event sign not exceeding 1.0m² in area and is placed on the Lot where the event is taking place, and may be placed the day prior to the event and must be removed immediately following the end of the event;
 - p. a memorial or historical sign, plaque or tablet not greater than 1.0 m²; and
 - q. an election sign not greater than 1.5 m² and not more than 2.0 m in height.

5.1.3. Application Requirements for a Development Permit for a Sign

1. An application for a development permit to alter or erect a sign must be made to the Development Authority and must include the following:
 - a. letter of consent from the landowner;
 - b. a copy of sign drawings with dimensions and copy area of the sign;
 - c. materials and finishes;
 - d. method of illumination, if applicable;
 - e. mounting details or method of support;
 - f. mounting height or clearance to grade;
 - g. the amount of projection of the sign from the building, if any;
 - h. a site plan showing all other existing signs and the proposed sign location in relationship to Lot Lines, parking areas and buildings; and
 - i. in the case of freestanding signs, an elevation plan is required showing the height of the sign in relationship to the height of the principal building taking into account the gradient of the Site.

5.1.4. Signs on Municipal Property

1. A federal, provincial or municipal election sign may be located on municipal property provided that it complies with all other regulations.
2. The Development Authority may approve placement of an entrance sign or property marketing sign on municipal property.
3. Any sign erected by the Municipality is allowed on municipal property.
4. Signs located on municipal property without the permission of the Municipality may be impounded and destroyed without notice.

5.2.0.

General Provisions for a Sign

1. The sign type must be shown to be allowed in the land use district where the sign is being installed by being shown as a Permitted Use or Discretionary Use in Table 5.2.0.a. or Table 5.2.0.b, with the exception of Planning Bylaw Notice Signs.
2. The dimensions, including the height and copy area of a sign and the number of signs must be in accordance with Table 5.2.0.a. and Table 5.2.0.b.
3. A sign must be maintained in good and safe structural condition and be periodically repainted or resurfaced.
4. No sign may obstruct the sightline of a pedestrian or the driver of a vehicle with respect to access to or egress from a road, lane or driveway, or detract from the visibility or effectiveness of any traffic control device, in particular, portable and freestanding signs must be set back a minimum of 2.0 m to any driveway or access.
5. No sign may be posted or affixed to municipal trees or landscaping, utility fixtures or traffic control signs or devices.
6. A sign, or sign structure, must be set back a minimum of 0.50 m from any Lot Line and no part of the sign itself may encroach onto the Adjacent property, with the exception of a projecting sign or a canopy sign, which may encroach on road rights of way.
7. The electrical power supply to any sign must be routed underground where the sign is located on the ground.
8. A sign must not be erected, operated, used or maintained if:
 - a. it displays words, phrases, symbols, lights or characters used in a manner which may mislead, confuse or otherwise interfere with pedestrian or vehicle traffic on a road which may include but is not limited to “stop”, “look”, “danger”, “one way”, or “yield”, except for traffic control signs approved as part of a development permit; or
 - b. it displays lights which may be mistaken for the flashing lights customarily associated with danger or with those used by police, fire or other emergency vehicles.
9. A sign may be illuminated, but must not flash nor have flashing lights, strobe lights or search lights.
10. A minimum 15 m separation is required between all sign types on the same Lot, except for window, fascia, or projecting signs.
11. A construction sign relating to a new Development in accordance with a development permit must be removed within seven days following the completion of the Development.

TABLE 5.2.0.a. – SIGN REGULATIONS FOR COMMERCIAL AND INDUSTRIAL DISTRICTS (also refer to Sections 5.1.0. to 5.4.0.)				
Sign Type	C1 – Local Commercial District	C2 – General Commercial District	C3 – Central Mixed Use District	M1 – Business Industrial District
Banner (horizontal or vertical)	- Permitted Use - no permit required - max. area 3.0 m ² - max. 3 signs where 30 m or less of frontage, max. 6 signs where more than 30 m of frontage	- Permitted Use - no permit required - max. area 3.0 m ² - max. 3 signs where 30 m or less of frontage, max. 6 signs where more than 30 m of frontage	- Permitted Use - no permit required - max. area 3.0 m ² - max. 3 signs where 30 m or less of frontage, max. 6 signs where more than 30 m of frontage	- Permitted Use - no permit required - max. area 3.0 m ² - max. 3 signs where 30 m or less of frontage, max. 6 signs where more than 30 m of frontage
Billboard	- not allowed	- not allowed	- not allowed	- not allowed
Directional	- Permitted Use - no permit required - max. area 1.0 m ²	- Permitted Use - no permit required - max. area 1.0 m ²	- Permitted Use - no permit required - max. area 1.0 m ²	- Permitted Use - no permit required - max. area 1.0 m ²
Election	- Permitted Use - no permit required - max. area 1.5 m ² - max. height 2.0 m	- Permitted Use - no permit required - max. area 1.5 m ² - max. height 2.0 m	- Permitted Use - no permit required - max. area 1.5 m ² - max. height 2.0 m	- Permitted Use - no permit required - max. area 1.5 m ² - max. height 2.0 m
Electronic	- Discretionary Use - permit required - max. area 6.0 m ² which must be part of a fascia or freestanding sign - max. 1 per Lot	- Discretionary Use - permit required - max. area 10.0 m ² which must be part of a fascia or freestanding sign - max. 1 per Lot	- not allowed	- Discretionary Use - permit required - max. area 10.0 m ² which must be part of a fascia or freestanding sign - max. 1 per Lot
Event	- Permitted Use - no permit required - max. area 1.0 m ² - max. height 1.0 m	- Permitted Use - no permit required - max. area 1.0 m ² - max. height 1.0 m	- Permitted Use - no permit required - max. area 1.0 m ² - max. height 1.0 m	- Permitted Use - no permit required - max. area 1.0 m ² - max. height 1.0 m
Fascia	- Permitted Use - permit required - max. area 1.0 m ² per m of building Facade	- Permitted Use - permit required - max. area 1.5 m ² per m of building Facade	- Permitted Use - permit required - max. area 1.5 m ² per m of building Facade	- Permitted Use - permit required - max. area 1.5 m ² per m of building Facade

TABLE 5.2.0.a. – SIGN REGULATIONS FOR COMMERCIAL AND INDUSTRIAL DISTRICTS (also refer to Sections 5.1.0. to 5.4.0.)				
Sign Type	C1 – Local Commercial District	C2 – General Commercial District	C3 – Central Mixed Use District	M1 – Business Industrial District
Freestanding	- Permitted Use - permit required - max. height 7.0 m - max. 1 per Lot frontage - max. area 10.0 m ²	- Permitted Use - permit required - max. height 9.0 m - max. 1 for every 50 m of frontage - max. area 17.0 m ²	- Permitted Use - permit required - max. height 7.0 m - only allowed on Lots with a frontage exceeding 20.0 m - max. area 17.0 m ² - max. 1 per 20.0 m frontage north of 47 Ave	- Permitted Use - permit required - max. height 9.0 m - max. 1 for every 50 m of frontage - max. area 17.0 m ²
Home Occupation	- not allowed	- not allowed	- Permitted Use - no permit required - max. area 0.30 m ² - max. 1 sign per Lot	- not allowed
Inflatable	- Permitted Use - permit required - max. height of the district - max. area 1 per 15.0 m of frontage	- Permitted Use - permit required - max. height of the district - max. area 1 per 15.0 m of frontage	- Permitted Use - permit required - max. height of the district - max. area 1 per 15.0 m of frontage	- not allowed
Menu Board	- Permitted Use - permit required - max. height 2.0 - max. area 5.0 m ²	- Permitted Use - permit required - max. height 2.0 - max. area 5.0 m ²	- not allowed	- Permitted Use - permit required - max. height 2.0 - max. area 5.0 m ²
Portable	- Permitted Use - permit required - max. height 3.0 m - max. area 5.0 m ² - max. 1 per business on a Lot - max. 1 per 30.0 m of frontage	- Permitted Use - permit required - max. height 3.0 m - max. area 5.0 m ² - max. 1 per business on a Lot - max. 1 per 30.0 m of frontage	- Permitted Use - permit required - max. height 3.0 m - max. area 5.0 m ² - max. 1 per business on a Lot - max. 1 per 30.0 m frontage north of 47 Ave	- Permitted Use - permit required - max. height 3.0 m - max. area 5.0 m ² - max. 1 per business on a Lot - max. 1 per 30.0 m of frontage

TABLE 5.2.0.a. – SIGN REGULATIONS FOR COMMERCIAL AND INDUSTRIAL DISTRICTS
(also refer to Sections 5.1.0. to 5.4.0.)

Sign Type	C1 – Local Commercial District	C2 – General Commercial District	C3 – Central Mixed Use District	M1 – Business Industrial District
Projecting (includes canopy marquee, overhanging)	- Permitted Use - no permit required - max. area 1.0 m ² per m of building Facade - may project 1.0 m into a required Yard Setback	- Permitted Use - no permit required - max. area 1.5 m ² per m of building Facade - may project 1.0 m into a required Yard Setback	- Permitted Use - no permit required - max. area 1.5 m ² per m of building Facade - max. 1.5 m over road right of way or public property & not allowed within 0.60 m of the curb of a public road	- Permitted Use - no permit required - max. area 1.5 m ² per m of building Facade - may project 1.0 m into a required Yard Setback
Property Marketing	- Permitted Use - permit required - max. area 3.0 m ² - max. height 3.0 m - min. 0.50 m required Yard Setback - max. 1 per 30 m of frontage	- Permitted Use - permit required - max. area 3.0 m ² - max. height 3.0 m - min. 0.50 m required Yard Setback - max. 1 per 30 m of frontage	- Permitted Use - permit required - max. area 3.0 m ² - max. height 3.0 m - min. 0.50 m required Yard Setback - max. 1 per 30 m of frontage	- Permitted Use - permit required - max. area 3.0 m ² - max. height 3.0 m - min. 0.50 m required Yard Setback - max. 1 per 30 m of frontage
Real Estate	- Permitted Use - no permit required - max. area 5.0 m ² - max. 1 per Lot	- Permitted Use - no permit required - max. area 5.0 m ² - max. 2 per Lot	- Permitted Use - no permit required - max. area 5.0 m ² - max. 1 per Lot	- Permitted Use - no permit required - max. area 5.0 m ² - max. 2 per Lot
Sandwich	- Permitted Use - no permit required - max. height 1.0 m - max. area 1.0 m ² - max. 1 per business	- Permitted Use - no permit required - max. height 1.0 m - max. area 1.0 m ² - max. 1 per business	- Permitted Use - no permit required - max. height 1.0 m - max. area 1.0 m ² - max. 1 per business	- Permitted Use - no permit required - max. height 1.0 m - max. area 1.0 m ² - max. 1 per business
Window	- Permitted Use - no permit required - max. area 50% of the window it is located within	- Permitted Use - no permit required - max. area 50% of the window it is located within	- Permitted Use - no permit required - max. area 50% of the window it is located within	- Permitted Use - no permit required - max. area 50% of the window it is located within

TABLE 5.2.0.b. - SIGN REGULATIONS FOR NON-COMMERCIAL AND NON-INDUSTRIAL DISTRICTS (also refer to Sections 5.1.0. to 5.4.0.)				
Sign Type	FD – Future Development District	R8 – High Density Residential District	All other Residential Districts	P1 – Parks District, P2 – Community Service District, and P3 – Utility District
Banner (horizontal or vertical)	- Permitted Use - no permit required - max. area 3.0 m ² - max. 3 signs where 30 m or less of frontage, max. 6 signs where more than 30 m of frontage	- Permitted Use - no permit required - max. area 3.0 m ² - max. 3 signs where 30 m or less of frontage, max. 6 signs where more than 30 m of frontage	- Permitted Use - permit required, limited to during site development and building construction	- Permitted Use - no permit required - max. area 3.0 m ² - max. 3 signs where 30 m or less of frontage, max. 6 signs where more than 30 m of frontage
Billboard	- Permitted Use - permit required - max. height 10.0 m - max. area 24 m ² - spaced 500 m from each other in the same direction	- not allowed	- not allowed	- not allowed
Directional	- Permitted Use - no permit required - max. area 1.0 m ²	- Permitted Use - no permit required - max. area 1.0 m ²	- Permitted Use - permit required, limited to during site development and building construction	- not allowed
Election	- Permitted Use - no permit required - max. area 1.5 m ² - max. height 2.0 m	- Permitted Use - no permit required - max. area 1.5 m ² - max. height 2.0 m	- Permitted Use - no permit required - max. area 1.5 m ² - max. height 2.0 m	- Permitted Use - no permit required - max. area 1.5 m ² - max. height 2.0m
Electronic	- Discretionary Use - permit required - only allowed if convert from a billboard	- not allowed	- not allowed	- Discretionary Use - permit required - max. area 6.0 m ² - max. 1 per Lot - must be part of a fascia or freestanding sign

TABLE 5.2.0.b. - SIGN REGULATIONS FOR NON-COMMERCIAL AND NON-INDUSTRIAL DISTRICTS (also refer to Sections 5.1.0. to 5.4.0.)				
Sign Type	FD – Future Development District	R8 – High Density Residential District	All other Residential Districts	P1 – Parks District, P2 – Community Service District, and P3 – Utility District
Event	- Permitted Use - no permit required - max. area 1.0 m ² - max. height 1.0 m	- Permitted Use - no permit required - max. area 1.0 m ² - max. height 1.0 m	- not allowed	- Permitted Use - no permit required - max. area 1.0 m ² - max. height 1.0 m
Fascia	- Permitted Use - permit required - max. area 1.5 m ² per m of building Facade	- Permitted Use - permit required - max. area 1.0 m ² per m of building Facade	- not allowed	- Permitted Use - permit required - max. area 1.5 m ² per m of building Facade
Freestanding	- Permitted Use - permit required - max. height 7.0 m - max. area 10.0 m ² - max. 1 per Lot frontage	- Permitted Use - permit required - max. height 7.0 m - max. area 6.0 m ² - max. 1 per Lot frontage	- Permitted Use - permit required - only allowed as an entrance sign with the address & name of development - max. area 10.0 m ²	- Permitted Use - permit required - max. height 7.0 m - max. area 10.0 m ² - max. 1 per Lot
Home Occupation	- Permitted Use - no permit required - max. area 0.30 m ² - max. 1 sign per Lot	- Permitted Use - no permit required - max. area 0.30 m ² - max. 1 sign per Lot	- Permitted Use - no permit required - max. area 0.30 m ² - max. 1 sign per Lot	- not allowed
Inflatable	- Permitted Use - permit required - max. height of the district - max. 1 per 15.0 m of frontage	- not allowed	- not allowed	- Permitted Use - permit required - max. height of the district - max. 1 per 15.0 m of frontage
Menu Board	- not allowed	- not allowed	- not allowed	- not allowed

TABLE 5.2.0.b. - SIGN REGULATIONS FOR NON-COMMERCIAL AND NON-INDUSTRIAL DISTRICTS (also refer to Sections 5.1.0. to 5.4.0.)				
Sign Type	FD – Future Development District	R8 – High Density Residential District	All other Residential Districts	P1 – Parks District, P2 – Community Service District, and P3 – Utility District
Portable	- Permitted Use - permit required - max. height 3.0 m - max. area 5.0 m ² - max. 1 per business on a Lot - max. 1 per 150.0 m of frontage	- not allowed	- not allowed	- Permitted Use - permit required - max. height 3.0 m - max. area 5.0 m ² - max. 1 per business on a Lot - max. 1 per 30.0 m of frontage
Projecting (includes canopy marquee, overhanging)	- Permitted Use - no permit required - max. area 1.5 m ² per m of building Facade - may project 1.0 m into any required Yard Setback	- Permitted Use - no permit required - max. area 1.0 m ² per m of building Facade - may project 1.0 m into any required Yard Setback	- not allowed	- Permitted Use - no permit required - max. area 1.5 m ² per m of building Facade - may project 1.0 m into any required Yard Setback
Property Marketing	- Permitted Use - permit required - max. area 3.0 m ² - max. height 3.0 m - min. 0.50 m required Yard Setback - max. 1 per 30 m of frontage	- Permitted Use - permit required - max. area 3.0 m ² - max. height 3.0 m - min. 0.50 m required Yard Setback - max. 1 per 30 m of frontage	- Permitted Use - permit required - max. area 3.0 m ² - max. height 3.0 m - min. 0.50 m required Yard Setback - max. 1 per 30 m of frontage	- Permitted Use - permit required - max. area 3.0 m ² - max. height 3.0 m - min. 0.50 m required Yard Setback - max. 1 per 60 m of frontage
Real Estate	- Permitted Use - no permit required - max. area 5.0 m ² - max. 2 per Lot	- Permitted Use - no permit required - max. area 5.0 m ² - max. 1 per Lot	- Permitted Use - no permit required - max. area 1.0 m ² - max. 1 per Lot	- Permitted Use - no permit required - max. area 5.0 m ² - max. 1 per Lot

TABLE 5.2.0.b. - SIGN REGULATIONS FOR NON-COMMERCIAL AND NON-INDUSTRIAL DISTRICTS (also refer to Sections 5.1.0. to 5.4.0.)				
Sign Type	FD – Future Development District	R8 – High Density Residential District	All other Residential Districts	P1 – Parks District, P2 – Community Service District, and P3 – Utility District
Sandwich	- Permitted Use - no permit required - max. height 1.0 m - max. area 1.0 m ² - max. 1 per business	- Permitted Use - no permit required - max. height 1.0 m - max. area 1.0 m ² - max. 1 per business	- Permitted Use - permit required, limited to during site development and building construction - max. height 1.0 m - max. area 1.0 m ²	- Permitted Use - no permit required - max. height 1.0 m - max. area 1.0 m ² - max. 1 per business
Window	- Permitted Use - no permit required - max. area 50% of the window it is located within	- Permitted Use - no permit required - max. area 50% of the window it is located within	- Permitted Use - not permitted, except for a home occupation - max. area 0.30 m ² - max. area 50% of the window it is located within	- Permitted Use - no permit required - max. area 50% of the window it is located within

5.2.1 Calculation of Number of Signs

1. Where any provision of this Bylaw limits the number of signs in any circumstance, then for the purpose of determining the number of signs allowed:
 - a. a sign is considered to be a single display surface or display device containing elements organized, related and composed to form a unit;
 - b. a double faced sign is counted as a single sign; and
 - c. each element must be considered to be a single sign, where:
 - i. sign content is displayed in a random manner without organized relationships or elements; or
 - ii. relationships between elements of sign content are not clear.

5.2.2. Area and Separation Distances

1. Where any provision of this Bylaw limits the height of a sign, the height is calculated as the distance from finished grade to the highest point of the sign structure.
2. Where any provision of this Bylaw limits the two-dimensional area of any sign in any circumstance, then for the purpose of determining the total area of a sign:
 - a. the area must be calculated as the entire area within a single common continuous perimeter enclosing the extreme limits of the content of the sign; and
 - b. only one side of a double-faced sign is used for calculating area of a sign.
3. Where any provision of this Bylaw stipulates a separation distance between signs, the distance is calculated as the distance between the points where the sign structures are in closest proximity to each other.

5.3.0.

Enforcement Relating to Signs

1. Every sign owner and landowner must ensure that their signs are in compliance with the regulations of this Bylaw.
2. When a sign that is subject to this Bylaw no longer fulfils its function under the terms of a development permit or the Bylaw regulations, the Development Authority may issue an order for the removal of the sign to the sign owner or landowner, which may include:
 - a. removal of the sign and all related structural components;
 - b. restoration of the immediate area around the sign to the satisfaction of the Development Authority, including the ground or the building to which the sign was attached; and
 - c. payment of all costs related to the removal and restoration.
3. Where the Development Authority believes that a sign is not authorized or not in compliance with the regulations of this Bylaw and the Development Authority has written authorization from the landowner of the lands on which the sign is located to enter onto the property, the Development Authority may enter the property and remove the sign without prior notice to any person.
4. Immediately following the impoundment of the sign, the Development Authority may provide written notice to the sign owner, when the identity of such person is ascertainable.
5. The Development Authority impounding the sign may cause the sign to be destroyed or disposed of without incurring any obligation to compensate any party:
 - a. within 30 days of issuing the notice if the sign owner is ascertainable; or
 - b. within 30 days of impounding the sign if the sign owner is not ascertainable.
6. Prior to the destruction of a sign, the sign owner may reclaim a sign that has been impounded, but the sign will not be returned to the owner unless and until payment for all impoundment and storage fees are made in an amount as determined by Council.
7. Any order or action taken pursuant to this section will be subject to the right of appeal to the appropriate appeal body.

5.4.0. Sign Regulation by Type

5.4.1. Banner Signs

1. A banner sign:
 - a. may be vertical or horizontal; and
 - b. may not be located on a roof of a building.

5.4.2. Billboard Signs

1. A billboard sign:
 - a. is only allowed on lands Adjacent to Highway 16A;
 - b. must be spaced a minimum distance of 500 m from other billboard signs facing the same traffic direction;
 - c. must be located a minimum of 1.0 m from a Lot Line; and
 - d. must be removed from a Site once Development of the Site occurs.

5.4.3. Election Signs

1. An election sign may only be erected:
 - a. in the case of a municipal election, on or after Nomination Day;
 - b. in the case of provincial or federal elections, the day the writ of election is issued by the responsible Chief Electoral Officer; or
 - c. in any other case, at an appropriate time determined by the Development Authority based on the circumstances of the election.
2. An election sign must be removed within 72 hours following an election.
3. There must be a minimum of 20 m between election signs of the same candidate or affiliation on a Lot.
4. A sign utilized for the purpose of an election that is greater than 1.5 m² and more than 2.0 m in height is not considered to be an election sign.
5. All other sign types utilized for the purpose of an election are subject to the regulations for that sign type.

5.4.4. Electronic Signs

1. **Electronic Display General Requirements**
 - a. An electronic sign may be allowed if they are integrated into a freestanding, billboard or fascia sign.
 - b. The electronic display feature of an electronic sign is a Discretionary Use.
 - c. Only one sign featuring an electronic display is allowed per Site or building.
 - d. An electronic display may be used instead of static sign content provided it does not exceed a maximum area as per Table 5.2.a. and Table 5.2.b.
2. **Electronic Display Surfaces Specifications**
 - a. Electronic display content must remain in place unchanged for a minimum of 6.0 sec before switching to new content.
 - b. The maximum transition time between each different electronic display on a sign is 0.25 sec.
 - c. The transition between each electronic display must not involve any visible effects, including but not limited to action, motion, fading in or out, dissolving, blinking, intermittent or flashing light, or the illusion of such effects.
 - d. Electronic display content must not include full motion video, movies, Moving Picture Experts Group (MPEG) or any other non-static digital format and the content must not

- be displayed using any visible effects, including but not limited to action, motion, fading in or out, dissolving, blinking, intermittent or flashing light, or the illusion of such effects.
- e. A sign featuring electronic display must be equipped with a functioning ambient light sensor and must be set to operate so as not to exceed the following limits at all times when the electronic display feature is functioning, as measured from the sign face at its maximum brightness:
 - i. a maximum of 5,000 nits from sunrise to sunset, as those times are established by the sunrise or sunset calculator of the National Research Council of Canada;
 - ii. a maximum of 300 nits from sunset to sunrise as those times are established determined by the sunrise or sunset calculator of the National Research Council of Canada; and
 - iii. the light levels around the electronic display must not at any time exceed the ambient light level by more than 5.0 LUX.
 - f. If the Development Authority determines that the brightness or light level of an electronic display exceeds the limits set out in Section 5.4.4.2.e., the Development Authority may direct the development permit holder to change the settings to bring the electronic display into compliance with this Bylaw, and if that direction is not complied with the Development Authority may issue an order directing that the electronic display be forthwith discontinued.
 - g. If any component of an electronic display fails or malfunctions such that the electronic display is no longer operating in compliance with this Bylaw or with the conditions of a development permit, the development permit holder must ensure that the electronic display is turned off until all components are fixed and operating in compliance.
 - h. The development permit holder for a sign featuring an electronic display must ensure that the Development Authority is at all times in possession of the name and telephone contact information of a person(s) having access to the technology controls for the sign, who can be contacted 24 hours a day if the sign malfunctions.

5.4.5. Fascia Signs

1. A fascia sign is allowed on each Facade of a building that does not face a Lot Line that is Adjacent to a residential district.

5.4.6. Freestanding Signs

1. Any support structure for a freestanding sign must be set back a minimum of 0.50 m from any Lot Line and no part of the sign itself may encroach onto or overhang an Adjacent property or road right of way.
2. A freestanding sign may be allowed in the C3 – Central Mixed Use District provided that there is no alternate sign location available to provide reasonable opportunity for communication.
3. A freestanding sign used as an entrance sign must identify the name of the Development it pertains to and may be required to be approved as part of the engineering drawings submitted with the development agreement.

5.4.7. Home Occupation Signs

1. A home occupation sign:
 - a. may indicate the address, owner and the name of a home occupation within a residence; and
 - b. must be placed outside against the wall of the dwelling or displayed from the inside of a window of the dwelling.

5.4.8. Inflatable Signs

1. An inflatable sign may be allowed year round.

5.4.9. Menu Board Signs

1. A menu board sign must:
 - a. be associated with a development that has a drive through service; and
 - b. adhere to Section 5.4.4.2. if electronic.

5.4.10. Planning Bylaw Notice Signs

1. Must be erected a minimum of 21 days before the public hearing date and removed within a maximum of 7 days following the public hearing date.
2. Must not exceed 3.0 m in height.
3. Must have a minimum Copy Area of 1.4 m² and a maximum Copy Area of 3.0 m².
4. Must be erected in a prominent and highly visibly location on the subject site.
5. Must utilize a template provided by the Development Authority.

5.4.11. Portable Signs

1. A portable sign may be double-faced.
2. Any support structure for a portable sign must be set back a minimum of 0.30 m within any property and no part of the sign itself will encroach onto an Adjacent private property, public property or road right of way.
3. The Development Authority must specify, in the development permit for a sign, the period of time during which a portable sign is allowed to be exhibited, which must not exceed one year.

5.4.12. Projecting Signs

1. An overhanging sign suspended under a canopy must:
 - a. have a minimum vertical clearance of 2.4 m; and
 - b. be spaced a minimum of 5.0 m from another projecting sign.
2. A projecting sign must:
 - a. have a vertical clearance of at least a minimum 2.4 m; and
 - b. be spaced a minimum of 5.0 m from another projecting sign.
3. A canopy sign must be erected in such a manner that the structural support elements are designed or concealed, to appeal as an integral part of the overall sign design and such that no angle iron bracing, guide wires or similar support elements are visible from a public roadway.
4. Where any projecting sign encroaches into a road right of way, the applicant must enter into an encroachment agreement with the Municipality and obtain insurance satisfactory to the Municipality.

5.4.13. Property Marketing Signs

1. A property marketing sign must be double-faced.
2. Any support structure for a property marketing sign must be set back a minimum of 0.50 m from any Lot Line and no part of the sign itself may encroach onto or overhang an Adjacent property or road right of way.
3. The Development Authority may approve the display of a property marketing sign for a period not exceeding three years and reapplication is required once the term of the permit has expired.
4. Property marketing signs advertising the same Development must be located with a minimum separation of 800 m.

5. Flags, banners, inflatable objects or similar features may not be added to property marketing signs.
6. A property marking sign must be removed within 30 days of completion of the Development.

5.4.14. Real Estate Signs

1. A real estate sign:
 - a. may only be displayed on the property to which it pertains during the time the property is being offered for sale or rent; and
 - b. must be located at least 1.0 m from a Lot Line.

5.4.15. Sandwich Board Signs

1. A sandwich board sign:
 - a. must be placed on private property, except for where a building is not Setback from a property line in the C3 – Central Mixed Use District, where it may be allowed on a municipal sidewalk provided that the sign is:
 - i. only displayed near the business to which it pertains near a lamp post, garbage receptacle, tree stand or against the building; and,
 - ii. neither located at an intersection, within the direct line of pedestrian traffic, within landscaping or against a tree;
 - b. may only be displayed during the business hours of operation; and
 - c. must be spaced a minimum of 15 m from any other sandwich board signs on the same Lot.
2. Only one sandwich board sign is allowed per business.

PART 6 - DEFINITIONS

6.1.0. List of Definitions

1. The following section outlines definitions for key terms and words frequently used in this Bylaw. Where a word is not defined, the Development Authority will apply generally accepted definitions within the context of Canada and specifically Alberta. Where a specific use generally conforms to the wording of two or more uses, the Development Authority will determine the appropriate definition based on the scale, character and purpose of what has been proposed.

6.2.0. Residential Uses

Accessory Dwelling

a self-contained Dwelling Unit that is accessory to another Dwelling Unit, which may include but is not limited to a basement suite, garage suite, garden suite, but does not include a Recreational Vehicle

Detached Dwelling

a Dwelling Unit which is completely detached and is inside a building that is not intended to be movable, does not have a visible towing apparatus or undercarriage, and must be on a foundation and connected to utilities

Duplex Dwelling

a building consisting of two Dwelling Units contained solely on one Lot

Live Work Unit

a building that contains one Dwelling Unit in addition to dedicated floor space for the purpose of conducting work where the work component may or may not be separate and distinct from the dwelling

Long Term Care Facility

a facility that provides 24-hour on-site nursing care with access to professional services including room and board services, light housekeeping services, personal care assistance, and social and recreational support

Multi-Unit Dwelling

a dwelling in either a residential building containing three or more Dwelling Units, or a building containing both residential and non-residential uses that may have a common entrance from the ground level, which is not a Row House Dwelling

Residential Vehicle Storage

Communal Recreational Vehicle storage in a residential area, which is typically coordinated by a homeowners association, condominium corporation, or a similar organization and serves the immediate residents, which is not commercial in nature and does not include the storage of equipment, containers, abandoned vehicles, or those uses identified under Outdoor Storage Accessory Development or Campground

Row House Dwelling

a dwelling in a building that is divided vertically into three or more Dwelling Units, each of which has an independent entrance to the exterior

Semi-Detached Dwelling

a building that is divided vertically by a common wall into two separate Dwelling Units with each Dwelling Unit having an independent entrance to the exterior and where each dwelling is located on a separate Lot

Supportive Living Facility

a residential Development in a congregate setting that provides access to professional services including room and board services, that may provide on-site nursing care, light housekeeping services, personal care assistance, and social and recreational support but does not include group homes

6.3.0. Business Uses

Adult Entertainment

live or pre-recorded performances that are characterized as being sexual in nature and predominantly involve the display or presentation of the nude human form

Auctioneering

the auctioning, storage and display of goods and equipment

Automotive and Recreation Vehicle Sales and Service

a development allowing for retail sales, rental or service of new or used automobiles, recreational vehicles and other similar motorized vehicles which may include snowmobiles, all-terrain vehicles, boats, utility trailers, Recreational Vehicles, but does not include Heavy Vehicle and Equipment Sales and Service

Bar

a development where the primary purpose is for people to purchase and consume alcoholic beverages on site, food and non-alcoholic drinks may also be available but with a limited menu where minors are typically prohibited during certain hours

Bed and Breakfast

a dwelling where a resident owner or manager provides overnight accommodation may provide meals for the public, not including short term rentals.

Campground

an area of land providing short term accommodation for Recreational Vehicles or tents, and may include but is not limited to amenities such as administrative offices, washroom facilities, playgrounds, food concession, firepits and firewood storage, water supply and general convenience stores but does not include a Detached Dwelling or a Park Model

Cannabis Consumption Facility

a development, or any part thereof, licensed to sell Cannabis to the public for consumption within the premises

Cannabis Production and Distribution Facility

a development in a stand-alone building used principally for one or more of the following activities as it relates to Cannabis: the production, cultivation and growing of Cannabis; the processing of raw materials; the making, testing, manufacturing, assembling, destruction or in any way altering the chemical or physical properties of semi-finished or finished goods or products; the storage or trans-shipping of materials, goods and products; or the distribution and sale of materials, goods and products to Cannabis Retail Sales businesses; not including Cannabis Retail Sales

Cannabis Retail Sales

a retail store licensed by the Province of Alberta where Cannabis and Cannabis accessories are sold to individuals who attend the premises

Car Wash

the commercial washing of vehicles

Child Care Service

a development that provides temporary care and supervision of children with facility-based early learning and care programs and may include daycares, out-of-school care, and preschools but does not include Family Day Home or a Major Home Occupation

Contractor Service

the provision of construction, maintenance and associated services that may require on-site storage of equipment or materials

Distillery

a facility, licensed by the Province, where beer, spirits and other alcoholic beverages are manufactured and may include the retail sale of products made on the premises for consumption off the premises and may also include a tasting room, where products made on the premises may be sold or provided to the public for consumption, but is not considered a restaurant or Bar, not including Cannabis Retail Sales

Earthworks

any work, operation, or activity that results in a disturbance of the earth, including but not limited to, the removal of topsoil, excavating, trenching, backfilling, recontouring, stockpiling and grading, which does not include activity related to a Development for which a development permit has been issued or a development agreement entered into with the Municipality

Energy Generating Facility

a large scale development whose primary purpose is the creation of electricity

Food and Drink Service

a development where the primary purpose is to sell food and drinks prepared for public consumption on or off-site and may include a restaurant and small-scale neighborhood pub, but excludes a Bar, Cannabis Consumption Facility and grocery stores

Funeral Home

the preparation of the dead for burial or cremation and the hosting of funeral services

Gas Bar

the retail sale of petroleum products, incidental auto accessories and may include a convenience store

Heavy Vehicle and Equipment Sale and Service

the retail sale or rental of heavy vehicles, industrial or mechanical equipment with a gross weight over 4500 kg, that are typically used in building, roadway, pipeline, oilfield and mining construction, manufacturing, assembling and processing operations and agricultural production along with maintenance services and the sale of parts of these vehicles and equipment, but does not include Automotive and Recreation Vehicle Sales and Service

Heavy Vehicle and Equipment Wash Facility

the commercial washing of large vehicles, including heavy trucks, equipment and Recreational Vehicles

Hotel

four or more rooms that provide temporary sleeping accommodations to the traveling public where access to the rooms is provided by a common interior corridor

Indoor Entertainment Establishment

commercial activity or recreation for amusement, primarily inside of an enclosed building, which may include but is not limited to arcades, golf simulators, escape rooms or bowling alleys

Indoor Farm

the cultivation and harvesting of plant or animal products primarily within enclosed buildings for the primary purpose of wholesale or retail sales, including vertical farms, hydroponic and aquaponics, not including Rural Farm, Community Gardens, or Cannabis Production and Distribution, unless operating pursuant to a registration certificate issued by the Federal Government for personal production or designated personal production for medical Cannabis

Indoor Sales and Service

a development where a business offers sales and services such as retail or commercial school activities strictly inside a building which may include a small animal clinic, art studio, hair salon, indoor market, office, pharmacy, pet grooming, retail store, grocery store, tailor shop, and tattoo studio but does not include Cannabis Retail Sales

Kennel

the boarding of household pets, which may include grooming, breeding, training, selling or any combination thereof.

Light Industrial

the manufacturing, processing, assembling, cleaning, repairing, servicing, testing, operation, storage, warehousing, distribution or trans-shipment of materials, finished goods, products or equipment, and may include storage, display, sale and technical or administrative support areas, where there are no or minimal impacts to Adjacent Lots from noise, smoke, dust, odour, vibration, glare or other nuisances associated with the industrial activities of the Site

Medium Industrial

the manufacturing, processing, assembling, cleaning, repairing, servicing, testing, operation, storage, warehousing, distribution or trans-shipment of materials, finished goods, products or equipment, and may include storage, display, sale and technical or administrative support areas where there are impacts to Adjacent Lots from noise, smoke, dust, odour, vibration, glare or other nuisances associated with the industrial activities of the Site

Microbrewery

a facility where beer, spirits, and other alcoholic beverages are produced and packaged, with an annual production capacity of no more than 25 000 hl, which is commonly associated with a Food and Drink Service and may include distribution, retail, or wholesale sales, either on-site or off-site, as well as tasting rooms

Mini storage

a commercial space for the storage of non-hazardous goods

Motel

four or more rooms that provide temporary sleeping accommodations to the traveling public where access to the rooms is provided through separate exterior entrances

Outdoor Display Area Accessory Development

an area of a commercial or industrial Lot used for the outdoor display of goods or equipment to be sold, leased or rented where such outdoor display is accessory to the Principal Use of the Lot

Outdoor Entertainment Establishment

commercial activity or recreation for amusement, taking place primarily outdoors, which may include but is not limited to mini golf or rock climbing

Outdoor Sales and Service

a development where sales and service activities take place primarily outdoors and may include storage or display which could present limited impacts to adjacent lots and includes a building and landscaping supply centre, greenhouse and garden centre

Outdoor Storage Accessory Development

the storage of goods and materials outside of buildings where such storage of goods and materials is accessory to the Principal Use of the Lot

Prefabricated Structure Accessory Development

a large structure consisting of factory-built components that is assembled on-site, which is used to shelter and store goods and equipment but not used for human habitation, such as a quonset or an air supported frame and fabric structure

Private Club

an establishment where members of a philanthropic, social service, non-profit, athletic, business or fraternal organization meet and conduct social or recreational activities

Recreation Facility

land or a building available to the public for sports and recreational activities that may include but is not limited to Swimming Pools, fitness centers, hockey rinks, gymnasiums, tennis courts, golf courses and related instructional or training services, as well as other athletic fields, and related spectator facilities and other accessory community uses

Recreational Vehicle Storage Facility

a facility for the storage of Recreational Vehicles on a single property

Recycling Depot

a facility used for the buying, collecting and temporary storage of recyclable materials that does not include construction and demolition materials, not including a salvage yard

Residential Sale Centre

a permanent or temporary building or structure for the display, marketing and selling of residential lands or buildings, which includes show homes

Rural Farm

development for the primary production of farm products such as: dairy products; poultry products; cattle, hogs, sheep and other animals; wheat or other grains; and vegetables or other field crops; not including Cannabis Production and Distribution, unless operating pursuant to a registration certificate issued by the Federal Government for personal production or designated personal production for medical Cannabis

Shipping Container Accessory Development

an accessory sealed unit used for the land and sea transport of goods and materials, which may also be used for storage

Snow Dump Site

a location to which snow is transported for storage or disposal

Surveillance Suite Accessory Development

a building that provides accommodation for the sole purpose of security personnel and may include a self-contained cooking facility, washroom facility and not more than one bedroom

Theatre

the showing of films on screens, or the presentation of live entertainment

Tourist Information Centre

an establishment where information is available regarding attractions, lodgings, and other items relevant to tourism

Veterinary Hospital

a development used for the temporary accommodation and care or impoundment of animals and livestock which may include space for the outdoor staging or storage of animals and livestock but shall not include cremation services

Warehousing

a facility for the indoor storage and distribution of goods and merchandise, excluding dangerous or hazardous materials, derelict vehicles or any waste material, and may include administrative offices and sales and display of goods related to the warehouse, not including Mini Storage or Cannabis Production and Distribution

6.4.0. Community Service Uses

Cemetery

land intended or used for the interment of human or animal remains, including but not limited to memorial parks, gardens of remembrance and columbaria

Community Facility

a meeting place for the general public for social, cultural, educational or recreational activities or the sale of goods in association with an event, such as a convention or tradeshow, which may also include accommodations for employees or students incidental to and exclusively devoted to a Principal Use of land

Community Garden

the cultivation and harvesting of plant products in urban areas for the primary purpose of social or community programming, beautification, education or recreation, not including Rural Farm, Indoor Farm or Cannabis Production and Distribution

Education Service

a development which provides education, training and instruction and may include accessory administrative offices, food services, or other related services and typically includes community colleges, polytechnics, public and private schools, and universities but use does not include private facilities used for training and instruction in a specific trade, skill, service or artistic endeavor such as a commercial school

Government Service

the use of land by the Municipal, Provincial or Federal Governments for the purposes of providing services to the public, but does not include a Hospital

Hospital

a facility that provides in-patient and out-patient health care to the public

Park

a parcel of land intended, through design or natural function, to provide opportunities for either active or passive recreation, including Natural Conservation Area

Religious Assembly

a facility for the worship and related religious, philanthropic or social activities, which includes accessory rectories, manses, meeting rooms, food preparation, service facilities, classrooms, dormitories and other buildings, and typically pertains to churches, chapels, mosques, temples, synagogues, parish halls, convents and monasteries

Transfer Station

a Site for the temporary disposal of waste

6.5.0. Signs**Abandoned Sign**

a sign which no longer advertises or identifies an existing business, owner, product, activity, lessee or service, or a sign for which a legal owner cannot be found

Banner Sign

a temporary sign constructed from non-ridged fabric that is attached to a pole, structure or building not including government flag

Billboard Sign

a sign that provides an advertising copy area a minimum of 17.0 m², and is permanently affixed to the ground by one or two uprights or braces

Copy Area

the entire area of the sign within a single common continuous perimeter enclosing the extreme limits of the advertising message, announcement or decoration on the sign, where for the purpose of area calculation will be the total area within the sign perimeter and when there are multiple sides, the calculation will be the average of all of the sides of the sign

Directional Sign

a sign designed to direct pedestrian or vehicular traffic

Election Sign

a temporary sign used for the purpose of announcing or supporting candidates or issues in any federal, provincial, municipal or school board election

Electronic Sign

any sign that uses changing lights to form a sign message or messages and where the sequence of messages and the rate of change are programmed and can be modified through electronic technology

Event Sign

a temporary sign used for the purpose of advertising and directing people to a community event, which may include but is not limited to craft sales, farmers markets, trade shows and neighbourhood yard sales

Fascia Sign

a sign attached to, placed flat against, marked or inscribed on the exterior wall or surface of any building, but does not include a mural or projecting sign

Freestanding Sign

a sign supported by one or more upright poles, columns, or braces permanently fixed in or on the ground and not attached to any buildings, which may include pylon, property management, entrance, construction, Fence and address signs

Home Occupation Sign

a sign which displays a home occupation in a residential district

Inflatable Sign

an object or device enlarged or inflated, which floats, is tethered in the air or is activated by air or gas that is attached to the ground or a building and used to advertise a message

Menu Board Sign

a sign which displays items for purchase or information in association with a Food and Drink Service and may be electronic

Portable Sign

a sign which is not permanently affixed to the ground or to a building and is generally situated on a trailer or a metal frame and is easily transported

Projecting Sign

a sign attached to a Facade which projects either perpendicularly or at an angle from the Facade and includes awnings and canopies

Property Marketing Sign

a temporary sign or flag erected for the purpose of marketing and providing direction to a subdivision or development

Real Estate Sign

a sign pertaining to the sale or lease of the land or buildings on which the sign is located

Roof Sign

any sign entirely erected upon a roof or above the Parapet Wall of a building

Sandwich Board Sign

a sign that is double faced or "A-frame," which is set on but not attached to the ground and has no external supporting structure, no illumination, and no electronic display

Specialized Sign

a sign that does not fall within any other definition of a sign type within this Bylaw, which may include but is not limited to special event signs

Window Sign

any permanent sign either painted on or attached to a window for the purpose of being viewed from outside the premises, not including Home Occupation Sign

6.6.0. General Definitions

Abut

immediately contiguous to, or physically touching, and when used with respect to Lots or Sites, means to share a common property line

Adjacent

land that Abuts a Lot or Site, and land that would Abut a Lot or Site if not for a road, lane, walkway, watercourse, utility Lot, pipeline right-of-way, power line, railway, or similar feature

Cannabis

cannabis plant, fresh cannabis, dried cannabis, cannabis oil and cannabis plant seeds and any other substance defined as cannabis in the *Cannabis Act* and its regulations, as amended from time to time and includes edible products that contain cannabis

Cannabis Accessory

a thing, including rolling papers or wraps, holders, pipes, water pipes, bongs and vaporizers, that is represented to be used in the consumption of Cannabis or a thing that is represented to be used in the production of Cannabis; if the thing is sold at the same point of sale as Cannabis

Cantilever

floorspace within a building that extends beyond the foundation wall and is not structurally supported from below

Corner Lot

a Lot Adjacent to the intersection of two or more roads

Deck

a horizontal structure of planks or plates 0.60 m higher than the final grade

Density

the number of Dwelling Units within a defined area of land

Development

as defined in the *Municipal Government Act*

Development Authority

as defined in the *Municipal Government Act*

Discretionary Use

a use of land or a building provided for in the districts of this Bylaw for which a development permit may be issued, upon an application having been made and the public notified in accordance with the *Municipal Government Act*

Dwelling Unit

a self-contained residence comprising of a kitchen, washroom, living and sleeping facilities with a separate entrance from the exterior of a building or from a common hall, lobby or stairway inside a building

Existing Building or Use

a building or use that legally existed prior to the effective date of this Bylaw

Family Day Home

a residence where six or fewer children, other than the children of the provider, are cared for and supervised for a portion of a day

Facade

means the entire face of a building including the parapet

Fence

a vertical, physical barrier constructed to prevent visual intrusion, unauthorized access or sound abatement

Flankage Lot Line

any Lot Line other than the shortest, where a Lot has two or more Lot Lines that Abut a public road, unless otherwise determined by the Development Authority in accordance to Section 3.8.1.

Flankage Yard

any yard not considered the Front Yard that Abuts a right of way or land used for the purposes of a public or private road of 6.0 m or more in width

Flare

an angled approach to a driveway from a road, which is wider than the access

Flood Fringe

the Flood Risk area and the Adjacent areas that would be flooded if the water level were 0.50 m higher than the areas that would be flooded after a 1 in 100-year storm event

Flood Risk

the area contained within a channel of a permanent or intermittent drainage, stream course or water body and the Adjacent areas that would be flooded with water after a 1 in 100-year storm event

Front Lot Line

the Lot Line of a Lot that Abuts a public road other than a lane, except that where a Lot has two or more Lot Lines that Abut a public road other than a lane, the shorter of these Lot Lines, unless otherwise determined by the Development Authority in accordance to Section 3.8.1.

Front Yard

any lands between the front Lot Line and the front of any building or structure

General Accessory Development

a building, structure, or use that is subordinate to, incidental to and located on the same Lot as the Principal Use; including but not limited to garages, sheds, storage buildings, gazebos, Swimming Pools and hot tubs; where a structure is attached to a principal building on a Site by a roof, an open or enclosed structure, a floor or foundation, or any structure below grade allowing access between the building and the structure, it is considered part of the principal building

Hard Surfaced

a ground covering consisting of asphalt, concrete, cement blocks, paving stones or other durable rigid or hard packing material which does not create dust, mud or loose material

Height Measurement

the vertical distance measured at finished grade at the front of the building or structure to the highest point of the building or structure

Landing

a horizontal structure affixed to a building to provide access that may form part of a staircase

Landscape

the preservation or modification of a site through the installation of trees, shrubs and plants which may incorporate additional elements such as crushed rock, pavers, bricks and stones but does not include asphalt or monolithic concrete

Lot

as defined in the *Municipal Government Act*

Lot Area

the total horizontal area within the Lot Lines of a Lot

Lot Coverage

the percentage of a Lot that is covered by buildings or structures at or above the finished grade, including space required for off-street parking that may be developed as a future accessory building

Lot Depth

the distance between the midpoints of the Front Lot Line to the midpoint of the Rear Lot Line and in the case of a curved Lot Line, the midpoint of the curve

Lot Width

the narrowest horizontal distance between Side Lot Lines measured 8.0 m back along the Side Lot Lines from either the Front Lot Line or the Rear Lot Line, whichever is narrower

Major Home Occupation

a major home occupation is an accessory use of a dwelling or accessory development by a resident, where the business operation is conducted on-site and may result in a higher level of activity or impact on the surrounding neighborhood, such as increased traffic, parking demand, or noise, while preserving the residential character of the area and excludes Family Day Homes

Minor Home Occupation

a minor home occupation is a home-based business operated by a resident, where the business is primarily conducted within the dwelling as a home office and the business must have little to no impact on the neighborhood, must not change the residential character of the dwelling, and must not involve outdoor storage, client visitation, or non-resident employees.

Mural

a pictorial representation designed or intended to reflect a thematic or artistic expression rather than advertising a concept

Natural Conservation Area

a Park set aside for conservation of natural features or areas of cultural or scenic value, which are intended to be kept in a natural state with limited development of pathway and

similar Landscape elements that would not impact natural landscaping and drainage patterns

Net Residential Density

combined total number of Lots that may potentially contain one or more dwellings divided by the combined total area of such Lots

Off-Street Loading

a space provided on a Lot or Site to accommodate a vehicle on a temporary basis for loading and unloading of commodities

Parapet Wall

that part of an exterior, party or fire wall extending above the roof line or a wall which serves as a guard at the edge of a balcony or roof

Park Model

a portable structure built on a chassis and mounted on wheels that provides temporary accommodation for recreation, camping or seasonal use, separate from Recreational Vehicles, and will not be used as a permanent dwelling

Parking Facility

a Lot with the primary function of providing vehicular parking, which typically includes surface parking Lots or parking structures located above or below grade

Permitted Use

a use of land or a building provided for in the districts of this Bylaw for which a development permit will be issued if an application is deemed complete and it conforms to this Bylaw, or may be issued if an application is deemed complete and it does not conform to this Bylaw, upon the public being notified in accordance with the *Municipal Government Act*

Pie-Shaped Lot

a Lot where the width of the Lot widens with the depth of the Lot

Planning Bylaw Notice Sign

a notice sign as defined in the Public Advertisement Bylaw

Principal Use

the primary purpose or activity for which a piece of land or its buildings are designed, arranged, developed or occupied

Privacy Wall

a vertical, physical barrier constructed upon or fixed to a landing, balcony, Deck or similar structure to prevent visual intrusion

Rear Lot Line

the Lot Line or point of intersection of the side Lot Lines farthest from and opposite the front Lot Line

Rear Yard

that part of a Lot which extends across the full width of a Lot between the rear Lot Line and the nearest point on the exterior of the building or structure

Recreational Vehicle

a portable structure carried on a vehicle or a structure transported on its own wheels to provide temporary living accommodation for recreational or travel purposes, including

vehicles such as travel trailers, 5th wheel trailers, tent trailers, campers, motorhomes, converted buses, not including a manufactured home, Park Model, or converted vans

Setback

the minimum horizontal distance between a building or other structure and a Lot Line, watercourse, flood plain or any other feature, excluding the eaves

Side Lot Line

a Lot Line other than a Front or Rear Lot Line

Side Yard

that part of a Lot which extends from a Front Yard to the Rear Yard between the side Lot Line of a Lot and the exterior of the building or structure

Site

refers to one or more Lots or parcels for which an application for a development permit has been made, and may include roads, lanes, walkways and any other land surface upon which Development is proposed

Swimming Pool

a structure, basin or tank containing an artificially created pool of water that is greater than 0.6 m deep at any point and is used for swimming, recreation, bathing, diving, wading or other similar purposes and includes all buildings, equipment and facilities used in connection with it, including hot tubs, above grade and inground pools, which is not a Principal Use of a Site

Temporary Development

a development for which a development permit has been issued for a limited amount of time only and which may include outdoor storage of equipment, goods, and materials including but not limited to vehicles, heavy equipment, and construction material that is not related to a Principal Use of the Lot or where a Lot does not have a Principal Use

Yard

lands within a parcel

Schedule B: Land Use Districts Map

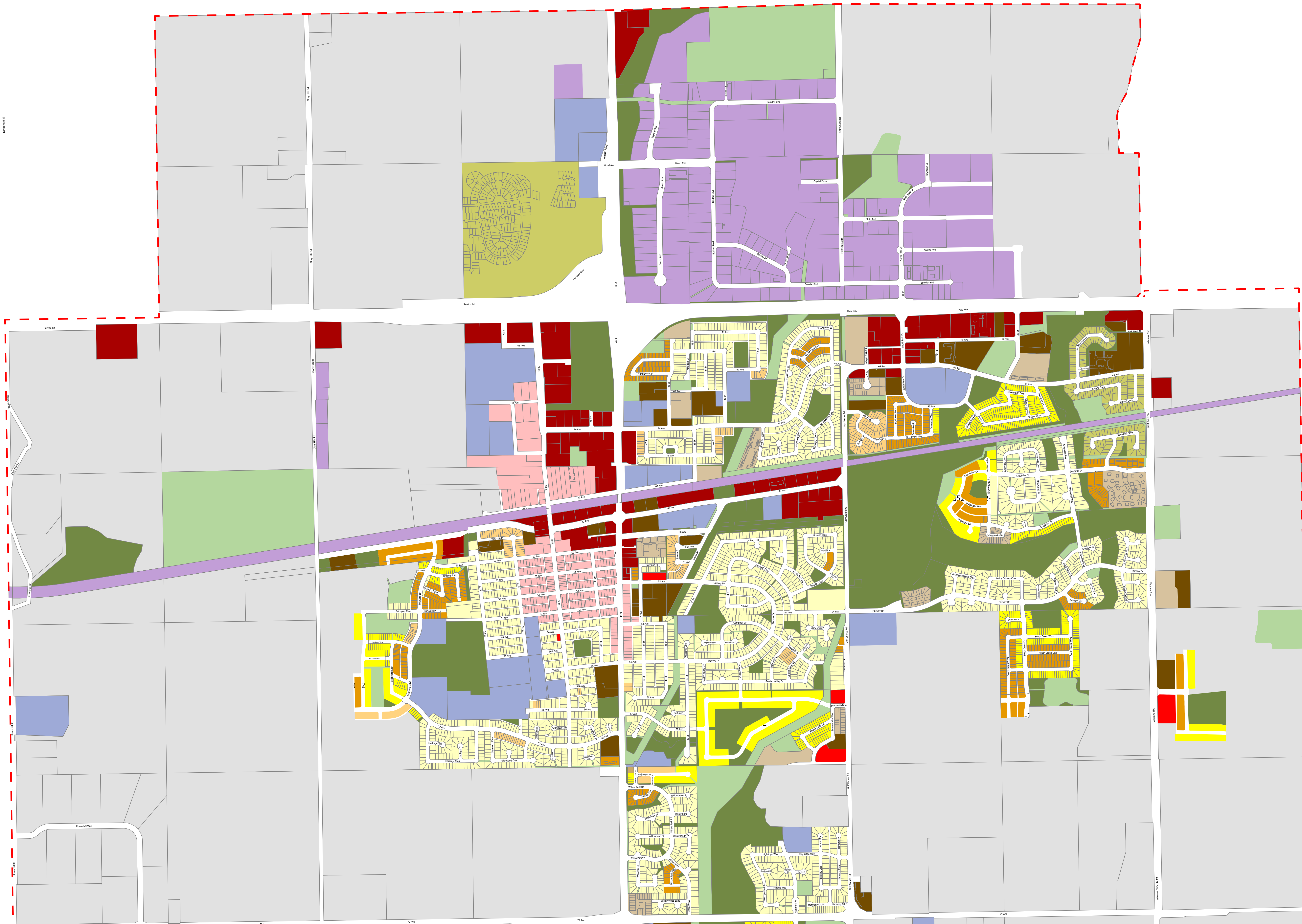

Town of Stony Plain

LAND USE DISTRICTS MAP

Bylaw 2735/LUO/26

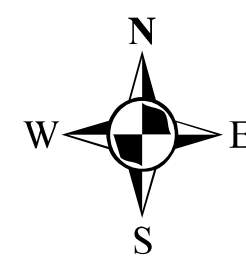

Map and documents made available to the public by the Town are not legally recorded maps, nor surveys and are not intended to be used as such. The maps and documents are created as part of a Geographic Information System (GIS) that compiles records, information, and data from various sources. The source data may contain errors or omissions. If errors or discrepancies are found please contact (780) 963-2151. The Town shall not be liable for any damages or claims that arise out of the user's access to, or use of the maps, documents and data provided. Parcel Data: AtlasIS For additional information please contact GIS Coordinator, gis@stonyplain.com, (780) 963-2151

Land Use Bylaw Districts

- | | | |
|---|-----------------------------------|----------------------------------|
| Residential Districts | Employment Districts | Other Land Use Districts |
| R1 – Large Lot Detached Dwelling Residential District | C1 – Local Commercial District | P1 – Parks District |
| R2 – Detached Dwelling Residential District | C2 – General Commercial District | P2 – Community Services District |
| R3 – Residential Park District | C3 – Central Mixed Use District | P3 – Utility District |
| R4 – Mixed Form Residential District | M1 – Business Industrial District | FD – Future Development District |
| R5 – Small Lot Mixed-Form Residential District | | |
| R6 – Comprehensively Planned Residential District | | |
| R7 – Multi-Unit Building Residential District | | |
| R8 – High Density Residential District | | |

Map Elements

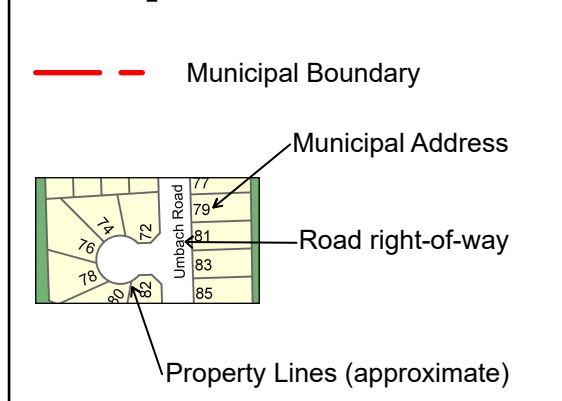

May 2026